

SUBMARINE DISPOSAL OF MILL TAILINGS FROM ON-LAND SOURCES - AN OVERVIEW AND BIBLIOGRAPHY -

An Overview and Bibliographic Compilation
of References on the Biological, Chemical,
Environmental, and Technical Aspects

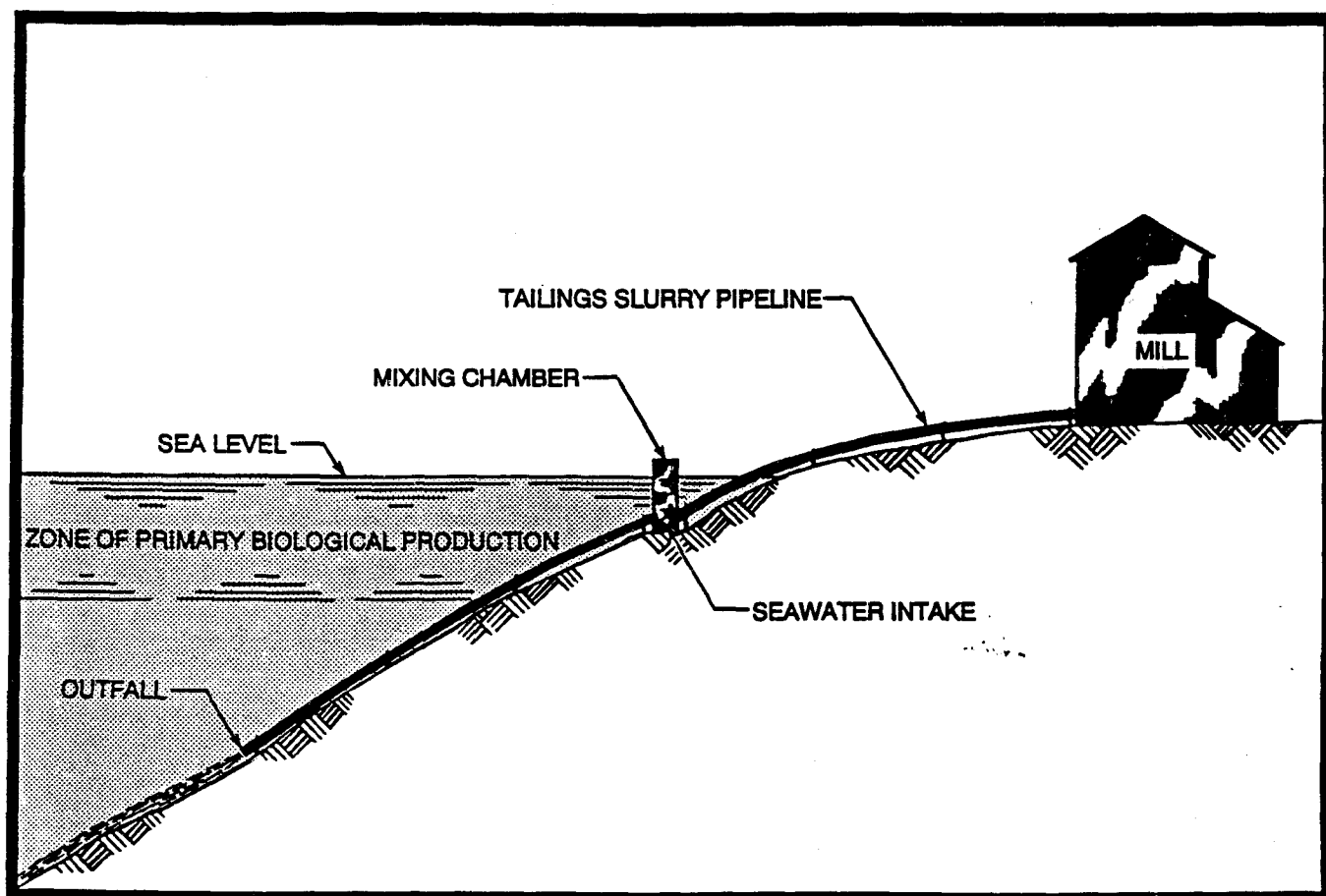

U. S. DEPARTMENT of the INTERIOR

Manuel Lujan, Jr., Secretary

BUREAU of MINES

T S Ary, Director



OFR 89-92

**SUBMARINE DISPOSAL OF MILL TAILINGS FROM ON-LAND SOURCES
- AN OVERVIEW AND BIBLIOGRAPHY -**

**An Overview and Bibliographic Compilation
of References on the Biological, Chemical,
Environmental, and Technical Aspects**

**By Roger L. Baer,
Gary E. Sherman and
Patrick D. Plumb**

**Engineering and Economic Analysis Section
Alaska Field Operations Center
U.S. Bureau of Mines
P.O. Box 20550
Juneau, Alaska 99802-0550**

CONTENTS

	<u>Page</u>
Abstract	4
Introduction	5
Acknowledgments	6
Disposal of Solid Wastes from Mining	6
Advantages of Marine Waters	6
Environmental Impact Assessment	7
Submarine Tailings Discharge Systems	7
Minimizing Impacts of Submarine Tailings Disposal	9
Island Copper Mine	9
Tailings Deposition into Rupert Inlet	14
Environmental Aspects	14
Regulatory Situation	16
Opportunities for Submarine Disposal	16
Quartz Hill Molybdenum Deposit	16
Alaska Juneau and Kensington Mines	17
The Bureau of Mines Approach	17
Bibliography	22
Methodology	22
Format and Content	22
Summary and Conclusions	24
References	24
Appendix. – Bibliography	26
Biological Citations	26
Chemical Citations	46
Environmental Citations	55
Technical Citations	79

FIGURES

1. Generalized Submarine Tailings Discharge System	8
2. Layout of Deaeration Tank for STD System	10
3. Location Map Showing Island Copper Study Area	11
4. Location of Island Copper Mine	12
5. Location of Island Copper Mine and Monitoring Stations	13
6. Tailings Depositional Contours in Rupert Inlet, January 1977	15
7. Location of Quartz Hill Molybdenum Deposit	18
8. Plan and Elevation Views of Boca de Quadra Fjord System	19
9. Location of Major Mines Within City and Borough of Juneau, Alaska	20
10. Overview of Tailings Disposal Options Considered for the AJ Mine	21
11. Distribution of STD References by Category	23

**SUBMARINE DISPOSAL OF MILL TAILINGS FROM ON-LAND SOURCES
- AN OVERVIEW AND BIBLIOGRAPHY -**

**An Overview and Bibliographic Compilation
of References on the Biological, Chemical,
Environmental, and Technical Aspects**

**By Roger L. Baer¹,
Gary E. Sherman² and
Patrick D. Plumb³**

ABSTRACT

Marine disposal of mill tailings has been practiced worldwide for over a century. However, only recently have the environmental effects of marine disposal been systematically studied. Some early attempts at marine disposal of tailings resulted in adverse impacts to marine life. However, recent advances in tailings disposal methods have included the introduction of engineered submarine tailings discharge systems, advanced environmental assessment and monitoring methods, and oceanographic modeling systems. Successful submarine tailings disposal (STD) has occurred at several mines.

The U.S. Bureau of Mines (BOM) has undertaken studies of the disposal of mining and milling wastes in the marine environment. The BOM Alaska Field Operations Center, Juneau, initiated a review of the technology, regulations, and economic aspects of STD. The review illuminated the need for organization of literature on the subject, therefore the Bureau compiled this extensive bibliography on marine disposal of mill tailings. The bibliography presented here contains 1483 references and is also available through diskette in the WordPerfect® format. A review of the references indicates that literature on submarine disposal inadequately covers the subject. The majority of the references listed only peripherally relate to the subject. Published literature on the engineering and environmental aspects of STD is severely limited.

¹Supervisor, Engineering and Economic Analysis Section.

²Physical Scientist (Now Supervisor, Engineering and Economic Analysis Section, Alaska Field Operations Center, Anchorage, AK).

³Environmental Engineer.
Alaska Field Operations Center, Juneau, AK.

INTRODUCTION

Marine disposal of mill tailings has been practiced worldwide for over a century. However, only recently have the environmental effects of marine disposal been systematically studied. Some early attempts at marine disposal of mill tailings resulted in adverse impacts to marine life (1).¹ However, recent advances in tailings disposal methods have included the introduction of submarine tailings discharge systems, advanced environmental assessment and monitoring methods, and oceanographic modeling systems. Within the last twenty years, successful examples of modern submarine tailings disposal include the Island Copper and Kitsault mines in British Columbia, Canada.

Today solid-waste disposal by the mining industry has to compete for space with other land uses, such as wilderness, wetlands, and recreation. In one case, after an analysis of the alternatives, some U.S. Government land managers identified submarine disposal of mill tailings as the preferred environmental alternative when compared to on-land disposal.

Known opportunities for use of submarine tailings disposal in the United States are located along the coastal-areas of Alaska. These opportunities include the Quartz Hill molybdenum deposit, and Kensington and Alaska Juneau gold mines.

Due to interest by industry and government in the potential for developing mines along coastal areas of Southeast Alaska, the Bureau has initiated multi-year projects to investigate various aspects of marine disposal of mill tailings. The Bureau of Mines' Alaska Field Operations Center has undertaken a study of the technology, regulations, and economic implications of submarine disposal of mill tailings. The Bureau's Spokane Research Center has begun an investigation of dissolution and reactivity of minerals and reagents from tailings in freshwater and marine environments. Submarine tailings disposal could provide a viable alternative to on-shore disposal, particularly in areas of fjord topography where land for conventional tailings management and disposal is limited.

Although currently prohibited in most cases by regulation in the United States, STD may become an important consideration in dealing with large volumes of tailings, especially when the environmental and economic impacts are compared with on-shore disposal alternatives.

This report is designed to give a brief overview of submarine disposal of mill tailings, to outline the approach the Bureau is taking in its studies of the subject, and to provide a bibliographic resource for those interested in the subject.

This report begins with a brief review of some of the mining industry's difficulties with on-land solid waste disposal. Included is a discussion of the pertinent characteristics of sea water and deep-water basins, and a review of the modern technology of submarine tailings disposal and its environmental implications. Also reviewed is the successful use of submarine tailings disposal at the Island Copper Mine in British Columbia. Minimization of environmental impacts from STD is discussed. The existing regulatory situation and present opportunities for use of submarine disposal in Southeast Alaska are summarized. Finally, current Bureau projects are listed and their objectives noted.

¹Underlined numbers in parentheses refer to citations listed in the "References" section of this report.

To provide a resource for those interested in the subject of STD, the Bureau has developed a database listing of approximately 1,500 documents. These references cover the biological, chemical, environmental, and technical aspects of STD and related issues. The bibliography contained in this report was generated from the database. This bibliography is available in digital form (PC compatible) in the WordPerfect® format. It should be noted that the vast majority of references listed are only peripherally related to the STD. By and large, the published literature directly related to STD was found to be severely limited.

ACKNOWLEDGMENTS

The Bureau of Mines would like to thank the following individuals for invaluable assistance without which this report could not have been completed:

Derek V. Ellis, University of Victoria, for contributing references to the bibliography and providing technical expertise; George W. Poling, University of British Columbia, for providing references and technical expertise; Kenneth M. Reim, U.S. Borax, for contributing bibliographic references; Roger W. Griffin, U.S. Forest Service, for providing technical review of the manuscript; John J. Kato and Robert H. Lambeth, U.S. Bureau of Mines, for technical review of the manuscript.

DISPOSAL OF SOLID WASTES FROM MINING

Today the mining industry has to compete for space for disposal of mill tailings and waste rock with other land uses, such as wilderness, wetlands, wildlife, aesthetics and recreation, to name a few. In coastal areas, development of mineral deposits can be stalled for a lack of on-land sites suitable for tailings and waste rock disposal. The selection of suitable tailings disposal sites is a sophisticated design issue. Government agencies require a detailed analysis of tailings disposal alternatives and sites. These analyses require knowledge of many factors about an area, such as the geology, hydrogeology, seismic potential, and drainage basin characteristics.

Extensive research is underway in the United States and Canada on the best way to design for long term disposal of solid wastes from mining. In Canada, groups jointly sponsored by industry and government, such as the British Columbia Acid Mine Drainage Task Force and the national level Mine Environment Neutral Drainage (MEND) program, are conducting research in this area. Because of results of studies by these groups, the Canadian regulatory community seems to be reaching a consensus that one of the best ways to minimize the potential for acid mine drainage is to keep tailings stored under water (2). The main reasons for this conclusion are that the oxygen content of water is small and oxygen diffuses slowly through water. Consequently, oxidation of tailings is minimized or eliminated. To date, the Canadian research efforts have been largely focused on fresh-water conditions.

The marine environment offers a tailings-disposal alternative for coastal mines. Although marine disposal of solid wastes from mines is not the answer in all cases, disposal of mill tailings and waste rock in marine water appears to have certain advantages over fresh water. Some of these advantages are discussed below.

ADVANTAGES OF MARINE WATERS

Besides minimizing oxygen diffusion, sea water is slightly alkaline with a pH ranging from 7.8 to 8.3 (3). Solubility of most metals in this pH range is at a minimum, and the alkaline pH will tend

to keep the tailings from reaching acidic conditions. Although salt-tolerant bacterial species that oxidize sulfides in seawater are known to exist (4,5), chloride kills many *Thiobacillus* species (including *T. ferrooxidans*, *T. thiooxidans*, *T. organoparus* and *T. acidophilus*) which account for most of the oxidation of sulfides on land. Additionally, most sulfide oxidizing bacteria require higher temperatures and oxygen concentrations than are normally found in the submarine environment. Consequently, waste rock at some mine sites that is potentially acid generating is being stabilized by using marine land-fills. Sea water is a natural flocculent, so turbidity from tailings outfalls is to some degree naturally reduced (6). Finally, deep oceanic water is frequently devoid of free oxygen, so deep disposal is an attractive alternative for preventing tailings oxidation.

The major concern with marine disposal systems is the potential for adverse impacts to human health and the marine environment, particularly from metals contamination and smothering of benthic organisms. By confining the materials to a relatively small area, environmental impacts are localized. Presently, most user countries are opting for some type of containment system for metal-bearing mill tailings. Deep, largely closed basins, such as the fjords of southeast Alaska are prospective containment systems.

ENVIRONMENTAL IMPACT ASSESSMENT

Marine disposal of mill tailings has been practiced worldwide since introduction of modern ore dressing processes over a century ago. However, only recently have the environmental effects of marine disposal been systematically studied (1). Environmental information has been collected by workers in the field on about two dozen sites worldwide. These studies indicate that, given the right circumstances, submarine disposal can be preferred over on-land disposal from an environmental perspective. The most complete set of environmental assessment data is the twenty-year record at the Island Copper Mine on Vancouver Island, British Columbia, Canada (1). This example is discussed below.

Older methods of marine disposal consisted of simply piping tailings to a beach and pouring them into the water with little thought for the long-term effects of these actions. Many advances in marine tailings disposal technology have been made in the last twenty years. These advances have included the introduction of sophisticated submarine discharge systems, advanced environmental assessment and monitoring methods, and oceanographic modeling systems which address both short and long-term environmental concerns (7).

SUBMARINE TAILINGS DISCHARGE SYSTEMS

A modern submarine tailings discharge system contains the slurry pipeline, deaeration (mixing) chamber, and an outfall pipeline (8). Figure 1 illustrates a generalized tailings discharge system. The purpose of the deaeration (mixing) chamber is two fold: (1) it allows air in the tailings slurry, which can cause suspension of tailings fines, to be released, and (2) seawater is mixed with the tailings to minimize the difference in density between the slurry fluid and the receiving sea water. The procedure reduces the chance of a buoyant plume of turbid water rising up from the tailings stream.

Assuming that the tailings slurry has the proper density, the tailings are moved by gravity to the outfall, which is usually located from 40 to 125 meters below the marine water surface. Since the zone of primary biological production in the water column is usually found within 30 meters of

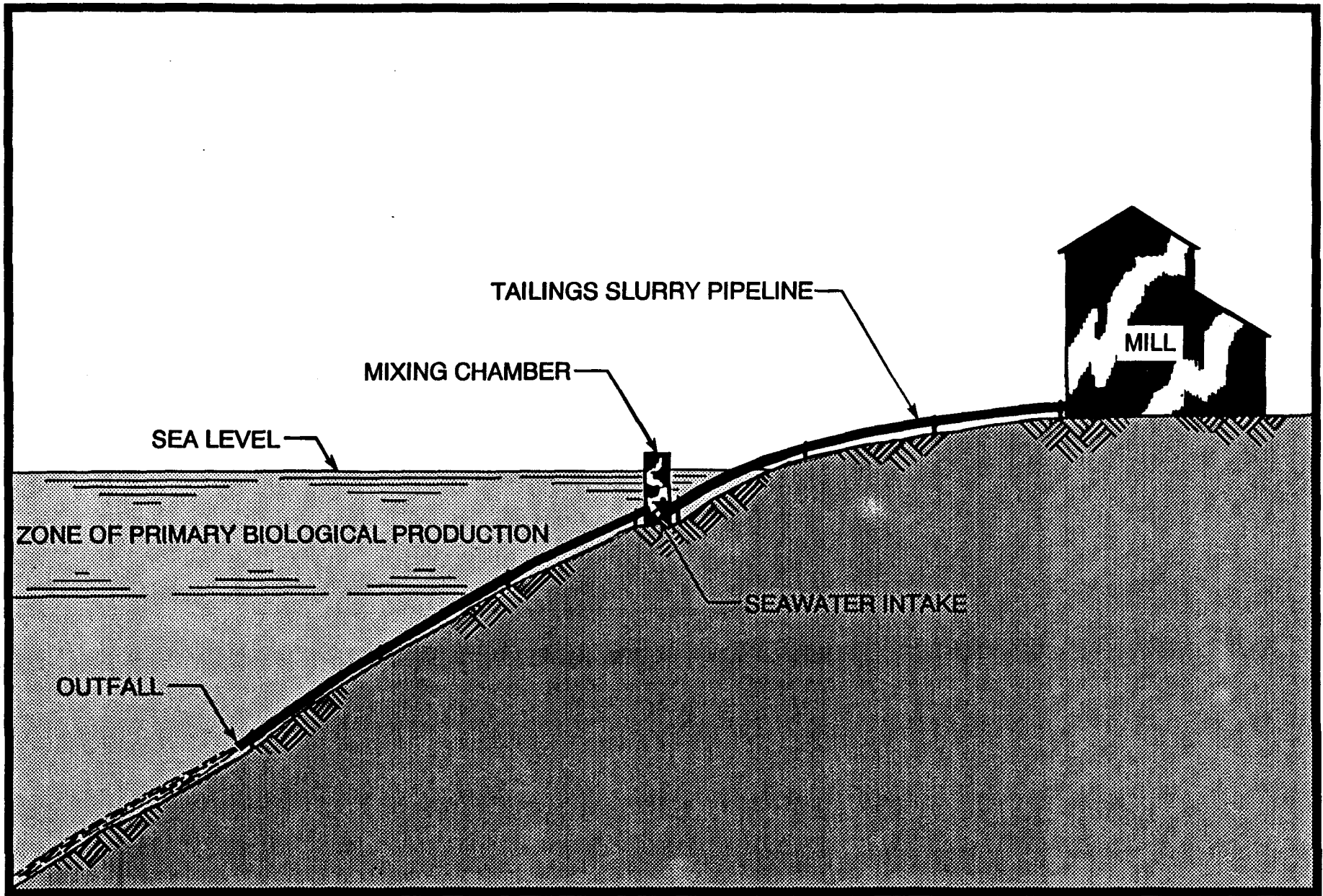

Figure 1. - Generalized Submarine Tailings Discharge System.

the surface, impacts on this zone are minimized (7). Salmon and other valuable fish species live and travel in this upper zone in Alaska and British Columbia.

Figure 2 illustrates the configuration of the deaeration and mixing chamber. Major parts of the system include tailings line, deaeration and mixing chamber, seawater intake lines, and outfall pipeline.

By modifying the design of the mixing chamber, the flow rates and density of the final tailings slurry can be controlled. Typically, seawater is used to dilute the tailings from the mill with from 1 to 6 parts seawater (8). A primary concern is for the tailings slurry to flow to the bottom of the containment basin and remain there. Within the last twenty years, successful examples of modern submarine disposal technology have included the Island Copper and Kitsault Mines in British Columbia, Canada.

MINIMIZING IMPACTS OF SUBMARINE TAILINGS DISPOSAL

Given the right combination of conditions, environmental impacts from STD appear to be minimal. These conditions include that: (1) the percentage of sulfide minerals in the orebody is relatively low, (2) the orebody contains no easily dissolvable toxic substances, such as toxic metal sulfates, (3) non-toxic reagents are used in the mill, or are detoxified before discharge, (4) the milling process does not generate secondary products toxic to marine life, (5) tailings water in the slurry from the mill is minimized to reduce transport of dissolved metals, (6) tailings are deaerated before emplacement, (7) proper fluid density is achieved and the density of the tailings liquids is equal to deep water densities, (8) the outfall is effectively placed, and (9) the depositional environment is relatively stable, such as at the bottom of a deep fjord (9).

The first five conditions above address toxicity issues, while the last four address turbidity issues. Deaerating the tailings and achieving proper fluid-densities are steps required to get the tailings onto the sea bottom and keeping them there. STD has been used with high sulfide tailings; however, currently there are questions concerning existing mines that require further study.

Some mines have had difficulty with turbidity and release of metals. For example, the Island Copper Mine has had some difficulty with an occasionally unstable depositional environment. This is due to the presence of a tidal jet created by water movement through Quatsino Narrows. The entrance to Rupert Inlet is unusually constricted, and on occasion during unusually high spring tides, a high velocity tidal-current descends to the seabed at the mouth of the inlet. On occasions, this high density current has resuspended tailings and caused their up-welling to the surface. Additionally, the Black Angel Mine in Greenland, which taps a high sulfide orebody, has had problems with bioaccumulation of metals in marine organisms (5). Proper modelling of the oceanographic and chemical conditions, and proper design and placement of the outfall can prevent or limit these types of problems.

ISLAND COPPER MINE

The Island Copper Mine is located on the northern end of Vancouver Island, British Columbia, Canada, as shown in figure 3. The mine, operated by BHP-Utah Mines Ltd., is located on Rupert Inlet, which is connected to the Pacific Ocean by Quatsino Sound and Quatsino Narrows, as shown in figure 4. Figure 5 shows the location of the mill, the open pit, and the mine waste rock landfill on Rupert Inlet.

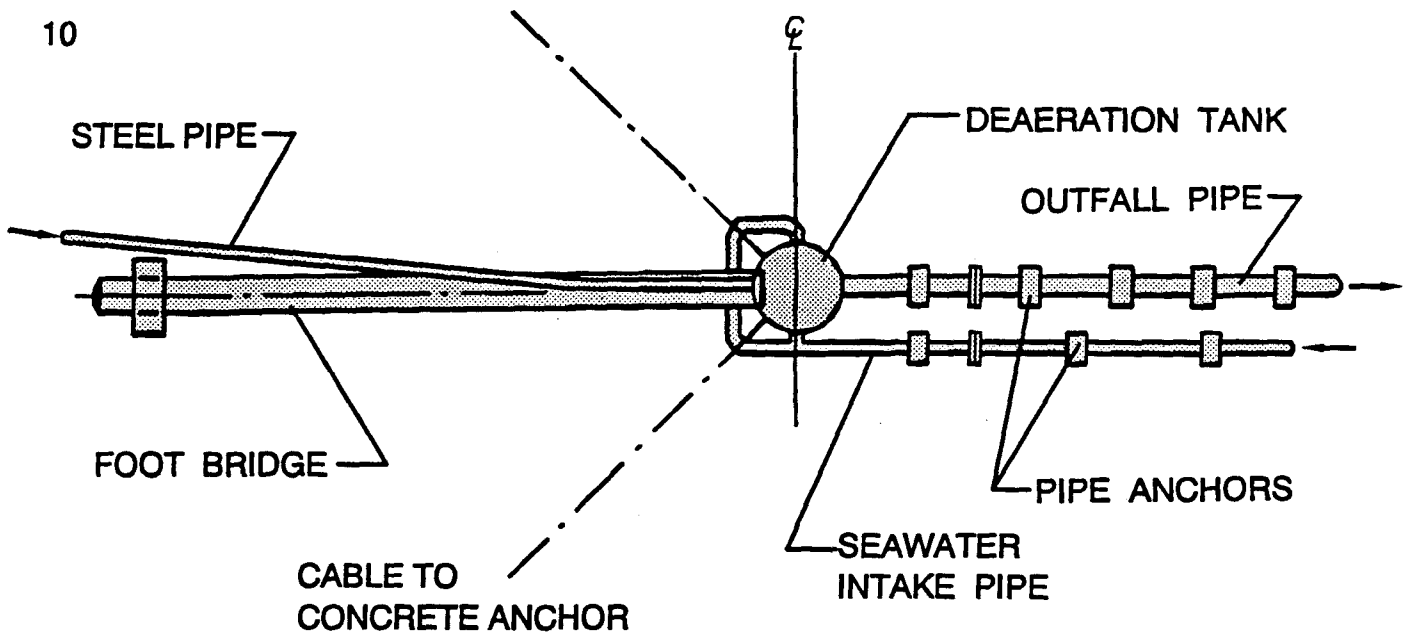

PLAN VIEW

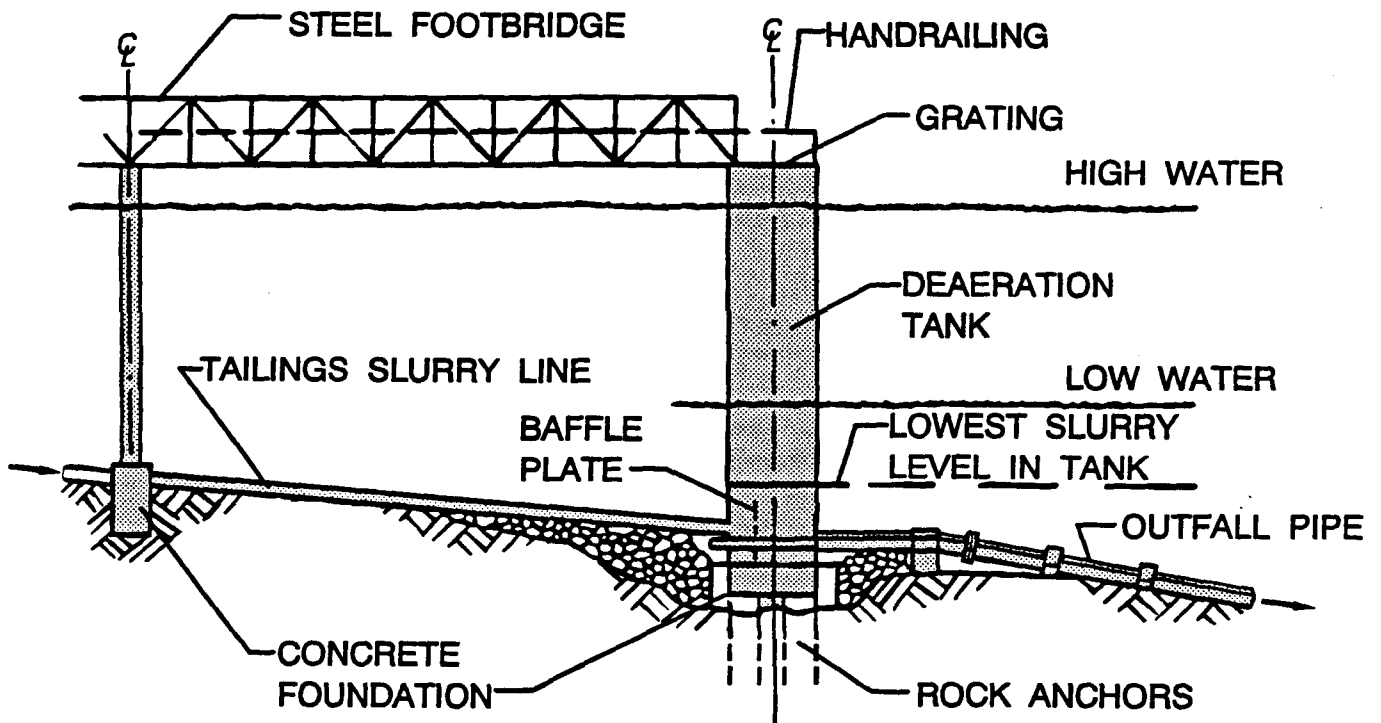

ELEVATION

Modified from Rescan, 1988 (17)

Figure 2. - Layout of Deaeration Tank for STD System.



Figure 3. - Location Map Showing Island Copper Study Area.

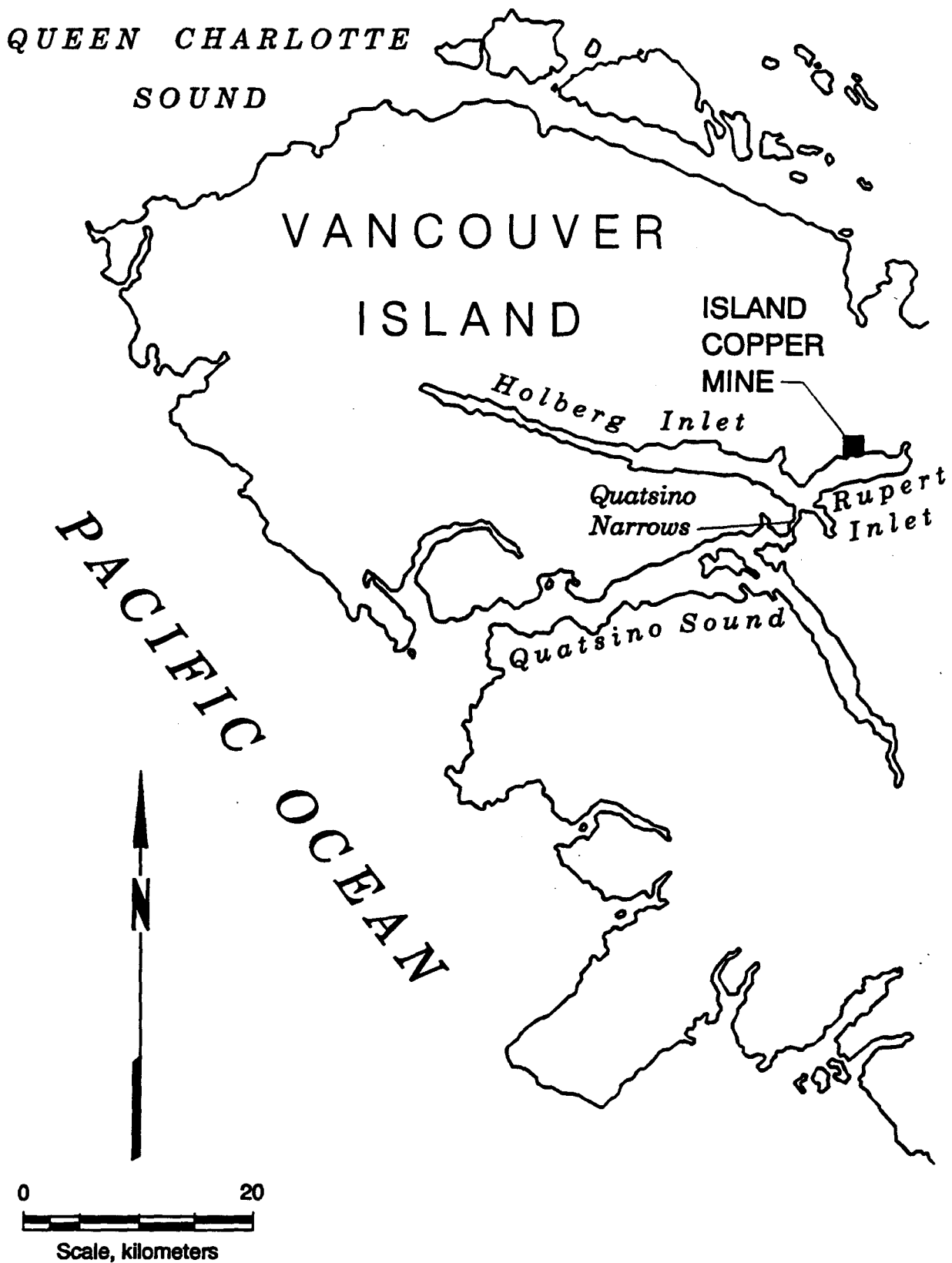
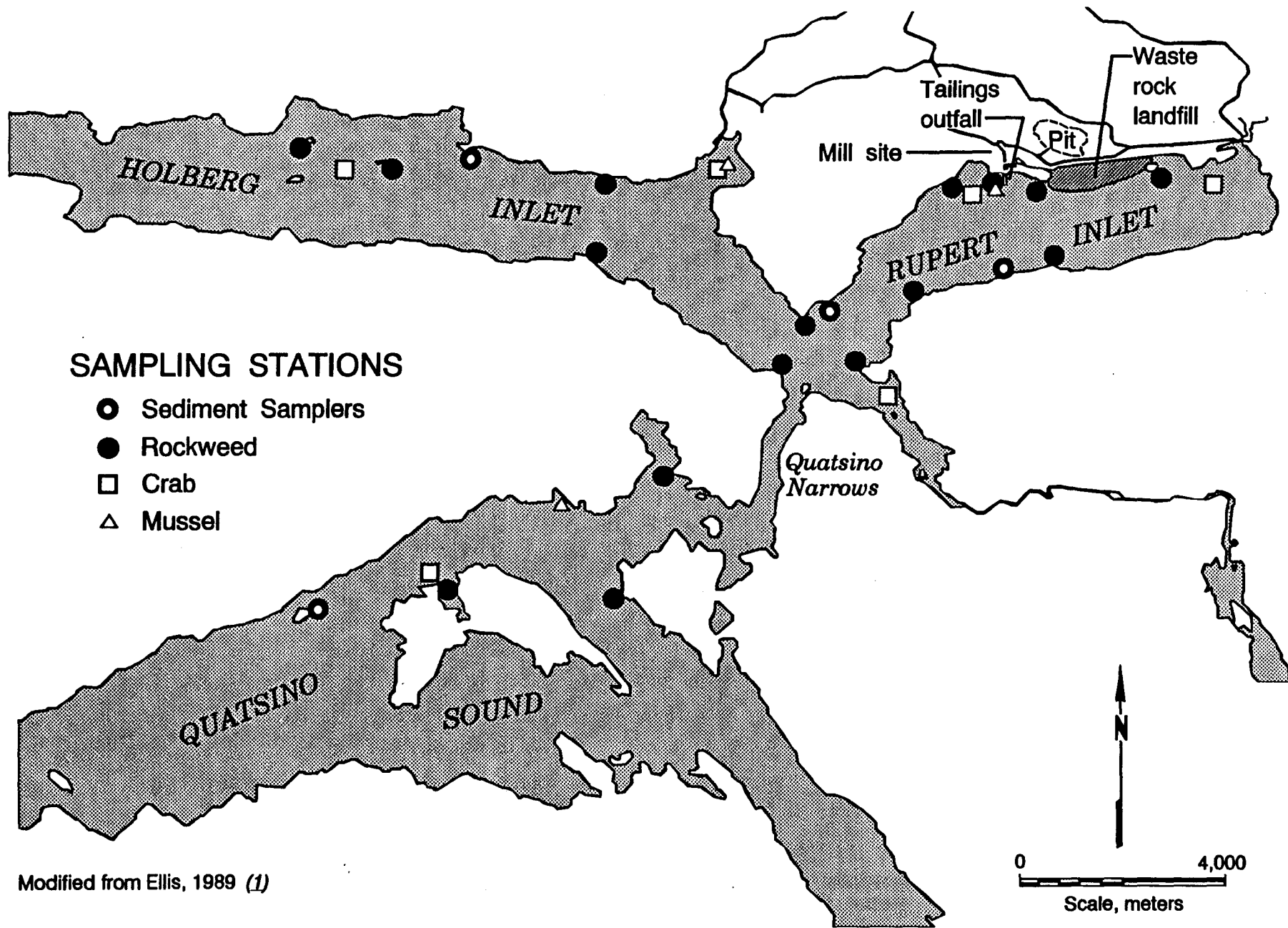

Figure 4. - Location of Island Copper Mine.



Modified from Ellis, 1989 (1)

Figure 5. - Location of Island Copper Mine and Monitoring Stations.

In the late 1960s, the mine management at Island Copper together with both provincial and federal regulatory authorities began evaluating alternatives for tailings and waste rock disposal. The company collected a year's environmental baseline data, and applied for a permit from the provincial government to discharge tailings into Rupert Inlet. Despite public controversy, the permit was granted (1).

The mine was required by the provincial government to undertake a comprehensive monitoring program. Scientists and engineers from the University of British Columbia have continually advised the mine on the STD operation since the operations began in 1971. The mine initiated an approach to outfall design and placement, and environmental monitoring that has developed into a state-of-the-art technology for placement of tailings into a marine environment.

The open pit is now approximately 2400 meters long, 1200 meters wide and 300 meters deep. To date, 300 million metric tons of tailings have been placed in the bottom of Rupert Inlet. The fjord is 260 meters deep at its deepest and thicknesses of up to 35 meters of tailings have accumulated, with the average thickness being approximately 25 meters (10).

The mill currently processes 48,000 metric tons of low-sulfide copper/molybdenum/gold ore per day. Using froth flotation and cyanide recovery processes, the mill separates the copper-bearing chalcopyrite, molybdenite minerals, and gold from the ore, and discharges a slurry of 45 to 50% solids in a basic solution at a pH of 10 (8).

The tailings outfall line enters into Rupert Inlet and connects with the deaeration (mixing) tank underwater about 100 meters offshore. Any air in the slurry is released and 2 parts seawater is mixed with 1 part tailings slurry.

TAILINGS DEPOSITION IN RUPERT INLET

The tailings slurry is discharged on the north side of Rupert Inlet at the outfall at a depth of 50 meters (9). The tailings slurry forms a density current or stream which flows down to the bottom of the inlet in a leveed channel, similar to a channel developed on an alluvial fan. A survey in 1977 revealed a single well-defined channel with levees extending 5 kilometers down the inlet from the outfall. Figure 6 shows tailings depositional contours in Rupert Inlet in January of 1977.

During this phase, the channel was 10 meters deep and 100 meters wide near the outfall. These dimensions progressively decreased away from the outfall. This channel caused rapid transport of tailings to depth on shallow slopes, about 2 degrees near the outfall, and 0.5 degrees near the bottom. The configuration of this channel has changed many times since this survey, as tailings continue to be deposited.

ENVIRONMENTAL ASPECTS

Monitoring programs include studies of outfall performance, tailings surveys, oceanographic characteristics, marine biology, fisheries, contaminant pathways, studies of nearby rivers and lakes, and weather (1). See figure 5 for locations of monitoring stations including sediment samplers and rockweed, crab, and mussel sample locations near the Island Copper Mine. The Environmental Control department employs 6 persons at the mine and has two boats for the environmental monitoring program (8).

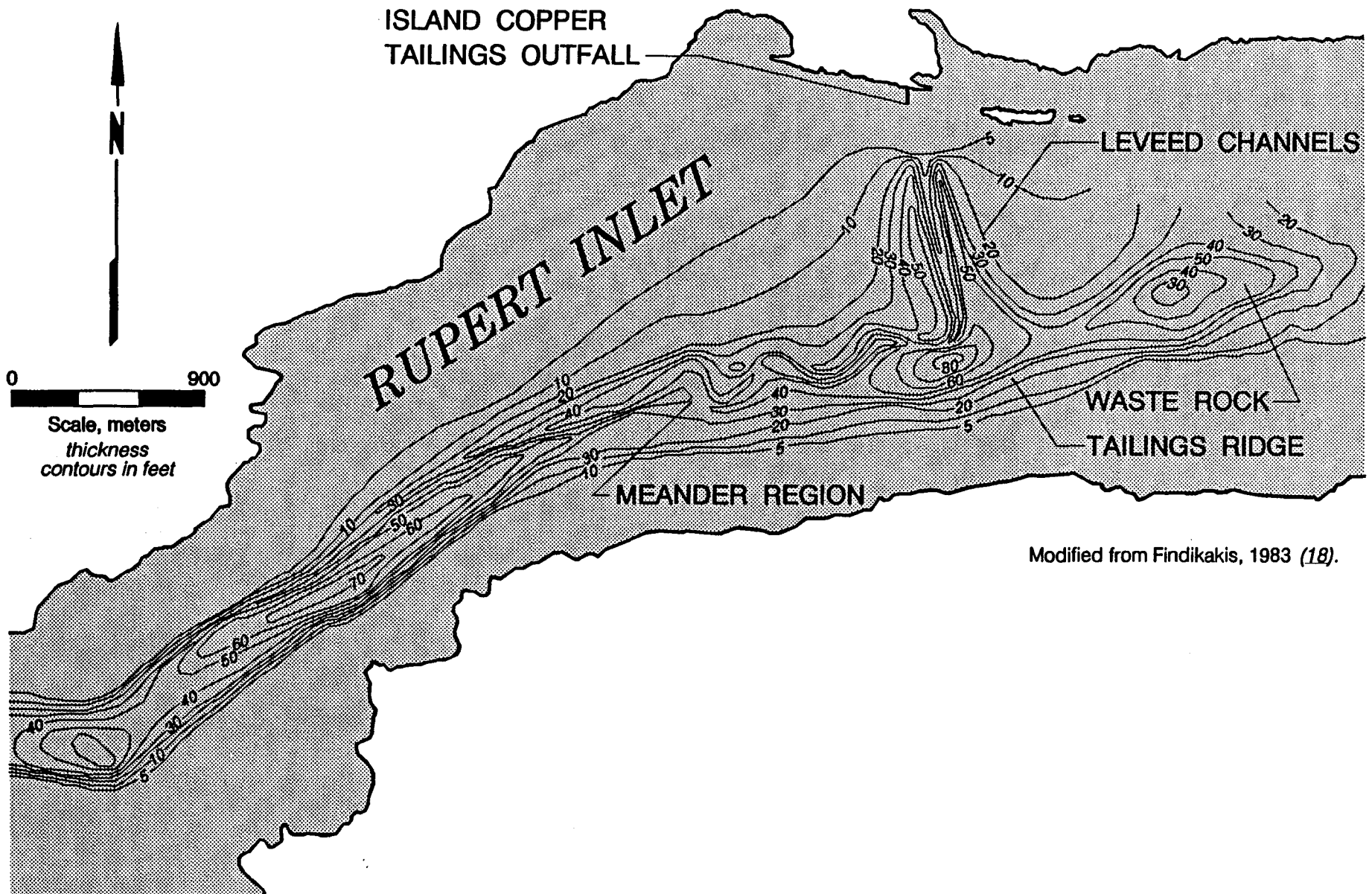

Modified from Findikakis, 1983 (18).

Figure 6. - Tailings Depositional Thickness Contours in Rupert Inlet, January 1977.

According to annual monitoring reports, there is no evidence of appreciable leaching of Cu, Mo, Cd, Pd, or Zn from sediments at the Island Copper tailings disposal site (1). Overall, the Island Copper Mine experience suggests that given the proper conditions, the most significant impact from STD is the direct smothering of benthic marine-life that can not move out of the way of the tailings. Researchers have found that this impact has been mitigated by the rapid recolonization of bottom dwelling creatures. Marine life has extensively recolonized the tailings-covered bottom within a one to two year period after tailings deposition has ceased in a particular area at the Island Copper site. Similar results have been found at other submarine tailings disposal sites in British Columbia, such as the Kitsault Molybdenum Mine (11).

REGULATORY SITUATION

Many industrialized societies, including the United States and Canada, are concerned about putting any waste materials into the oceans and therefore are hesitant to allow the placement of mining wastes in marine environments. This is largely because long-term impacts have been difficult to assess. Some early attempts at marine disposal of tailings resulted in adverse impacts to marine life (12).

Within the last three decades, Canada has allowed several mining operations to dispose of mill tailings in marine waters. However, Canadian authorities still prefer to have tailings placed in impoundments or in biologically-inactive fresh-water lakes (2). With special federal government permission, submarine disposal operations can be permitted in Canada if other alternatives are not available or not as desirable.

Currently, the mining industry in the United States is prohibited from using marine disposal of mill tailings by an Environmental Protection Agency (EPA) interpretation of the Clean Water Act. These regulations can be found in Title 40 of the Code of Federal Regulations (40 CFR 440). The EPA regulations prohibit the discharge of process wastewater to navigable waters from mills that use froth-flotation or cyanidation processes to recover copper, lead, zinc, gold, silver and molybdenum. This interpretation has not been tested in court. Some mining industry analysts believe that submarine discharge of mill tailings may be allowable under current law in certain instances (13).

OPPORTUNITIES FOR SUBMARINE DISPOSAL

Opportunities for use of submarine disposal of metal-bearing tailings in the United States are largely located in the coastal-areas of Alaska. The water-ways of Southeast Alaska appear to be particularly attractive for submarine disposal. Sites that could potentially use submarine disposal include the Quartz Hill molybdenum deposit and the Kensington and Alaska Juneau gold mines, as well as others in Southeast Alaska. To date, the best studied site in Alaska for submarine tailings disposal is the Quartz Hill molybdenum deposit.

QUARTZ HILL MOLYBDENUM DEPOSIT

U.S. Borax pursued the permitting of this project for several years. Because of an exemption specifically listed in the Code of Federal Regulations (40 CFR 440.100(d)), U.S. Borax was allowed by EPA to apply for a water discharge permit for a submarine tailings disposal system. The Environmental Impact Statement and the Record of Decision for the project by the U.S. Forest Service found that submarine disposal of mill tailings was the environmentally-preferred alternative. The Forest Service analysis found that a huge on-land tailings dam and

impoundment, which would eventually contain 1.5 billion tons of tailings, would have a greater adverse environmental impact than submarine disposal (7). Figure 7 shows the location of the Quartz Hill molybdenum deposit.

The controversy that surrounded this decision ultimately centered on which fjord the tailings should be deposited in, Wilson Arm or Boca de Quadra. Even though the EPA initially agreed with the Forest Service's assessment that submarine disposal was the environmentally preferred alternative, the EPA ultimately denied the U.S. Borax permit application for Wilson Arm (14). To date, the EPA has left the door open for an application for a permit to use Boca de Quadra. However, the company reported that use of this site rather than Wilson Arm will add \$59 million to the capital cost of the project, and substantially raise the mine's annual operating cost (7). The Quartz Hill deposit has recently been acquired from U.S. Borax by Cominco Alaska. To date, this new owner has not tried to permit this project.

A map and cross-sectional view of Boca de Quadra, figure 8, illustrates a fjord system typical of Southeast Alaska (7). The depth of the fjord is a maximum of 350 meters with an irregular bottom. Its length is 55 kilometers with sills that tend to isolate sections of the fjord into basins. Large amounts of tailings can be contained in one of these basins.

ALASKA JUNEAU AND KENSINGTON MINES

Figure 9 shows the location of major mines within the City and Borough of Juneau, Alaska. The Alaska Juneau (AJ) and the Kensington mines are historic gold mines with plans being developed for their reopening. Both are large scale mines that could potentially use submarine disposal of tailings. However, neither can take advantage of submarine tailings disposal because of the EPA prohibition. Both operations are proceeding with permitting efforts using on-land disposal plans (15,19).

Previous mining in the area from 1882 to 1944 utilized beach and marine waste disposal sites. Approximately 78 million metric tons (86 million tons) of mill tailings and about 58 million metric tons (64 million tons) of waste rock from mines along the Gastineau Channel were discharged into the channel (19).

Figure 10 is an overview of the tailings disposal options considered for the AJ mine. The five on-land tailings disposal sites and the two submarine disposal options are noted. Disposing of tailings in Taku Inlet presents an interesting possibility, in that the Taku River is constantly dumping large quantities of glacial sediment into Taku Inlet. Tailings deposited there would be buried by natural sediments in a relatively short time.

THE BUREAU OF MINES APPROACH

The Bureau of Mines, Alaska Field Operations Center, has undertaken a review of the technology, regulations, and economic aspects of submarine disposal of mill tailings. During 1991, the Bureau compiled the extensive bibliography included here. Results from the Bureau's review of the literature indicate that the literature on submarine disposal inadequately covers the subject. The majority of the references listed only peripherally relate to the subject. Published literature on the engineering and environmental aspects of STD is severely limited.

Future Bureau work will consist of developing a policy-oriented analysis of submarine tailings disposal use for Alaska and the contiguous United States. To support the systematic

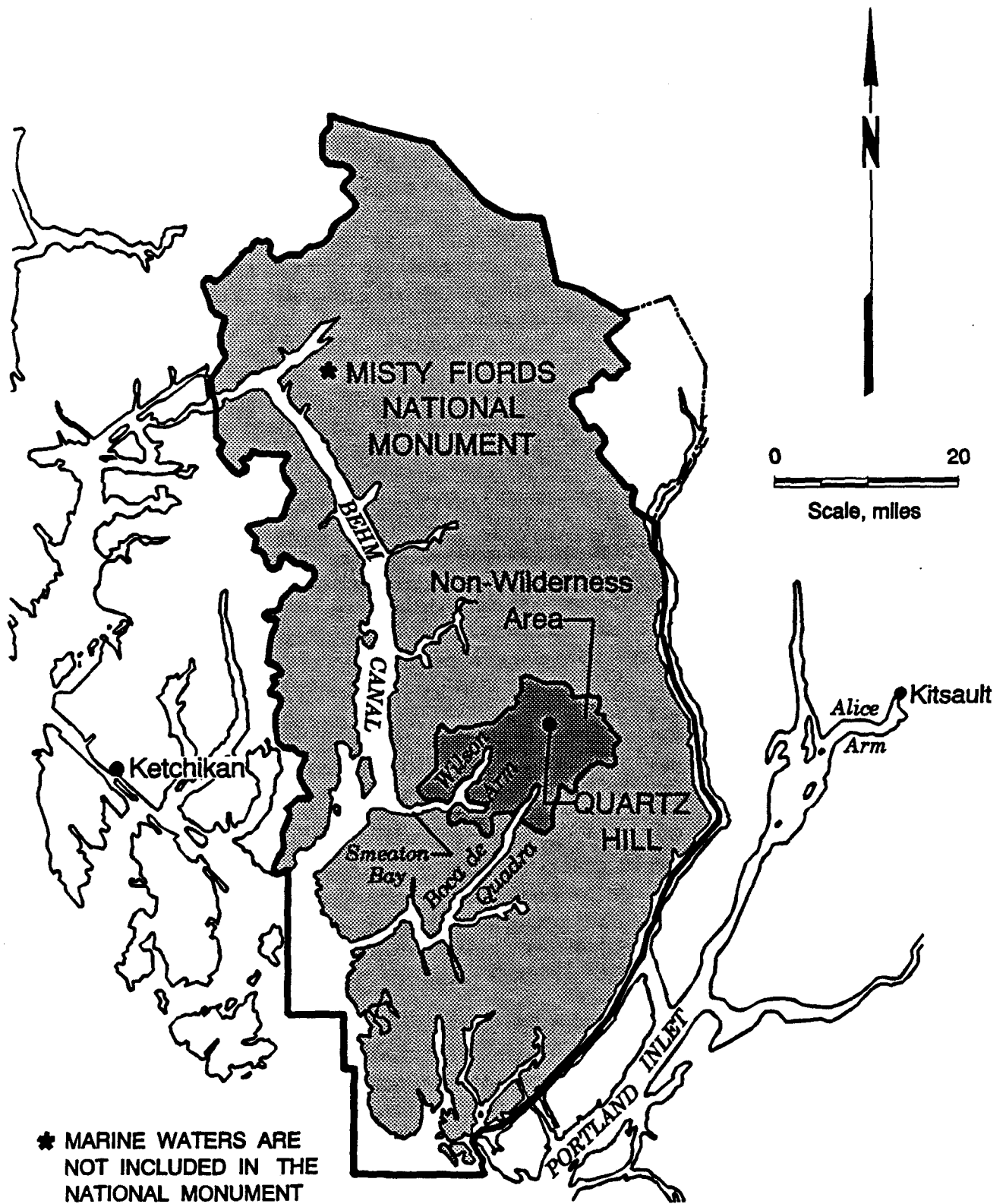

Modified from U.S. Forest Service, 1988 (7).

Figure 7. - Location of Quartz Hill Molybdenum Deposit.

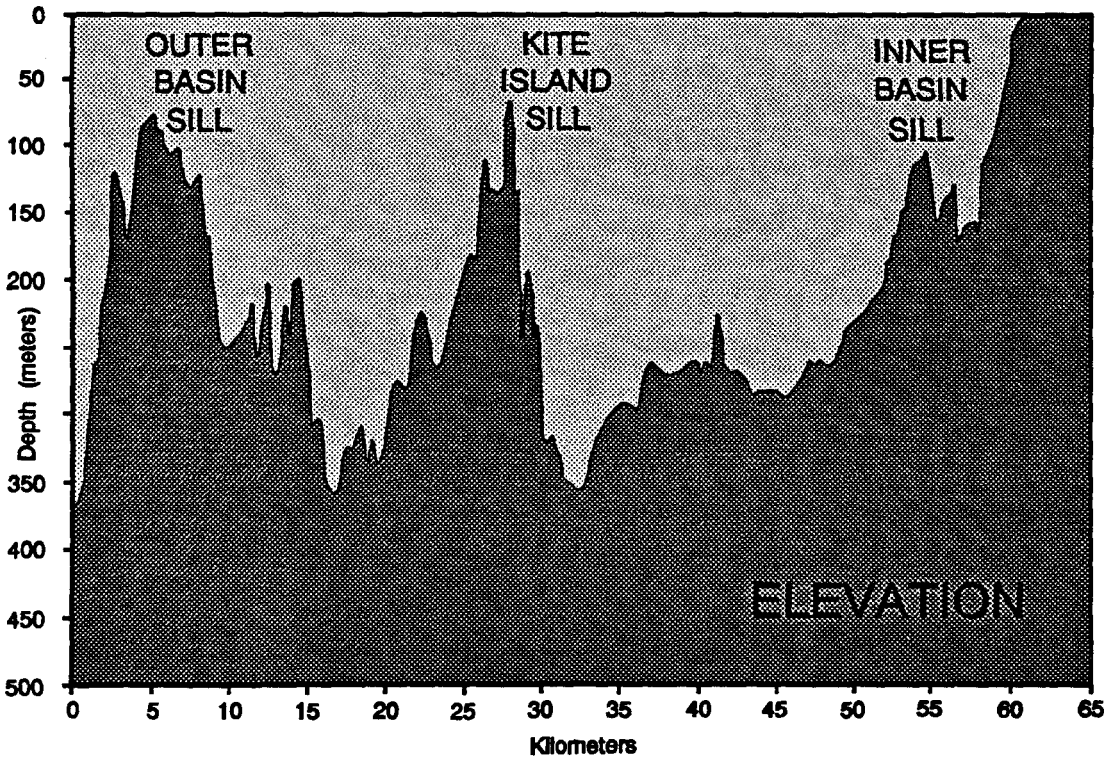
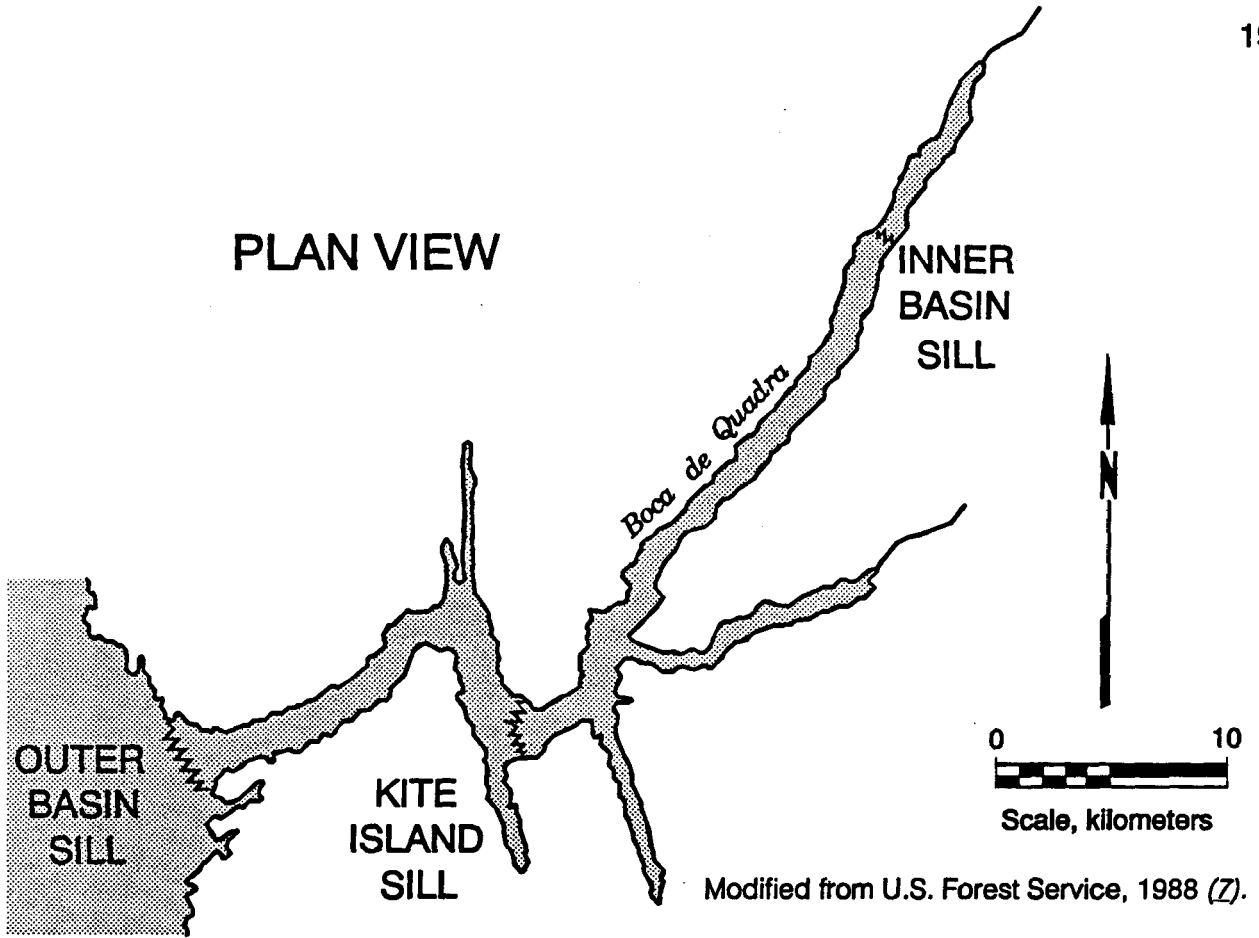

Figure 8. - Plan and Elevation Views of Boca de Quadra Fjord System.

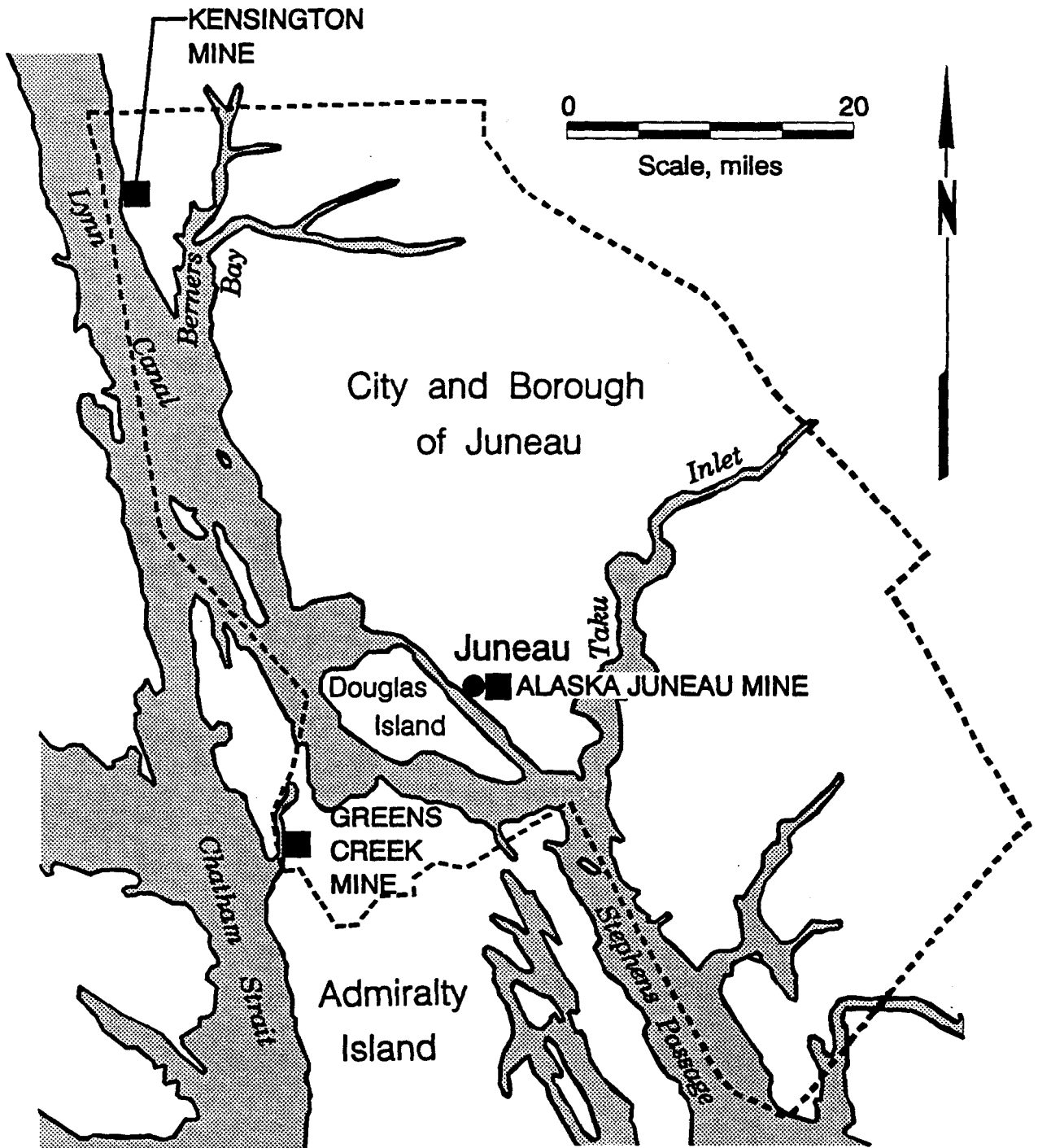

Figure 9. - Location of Major Mines Within City and Borough of Juneau, Alaska.

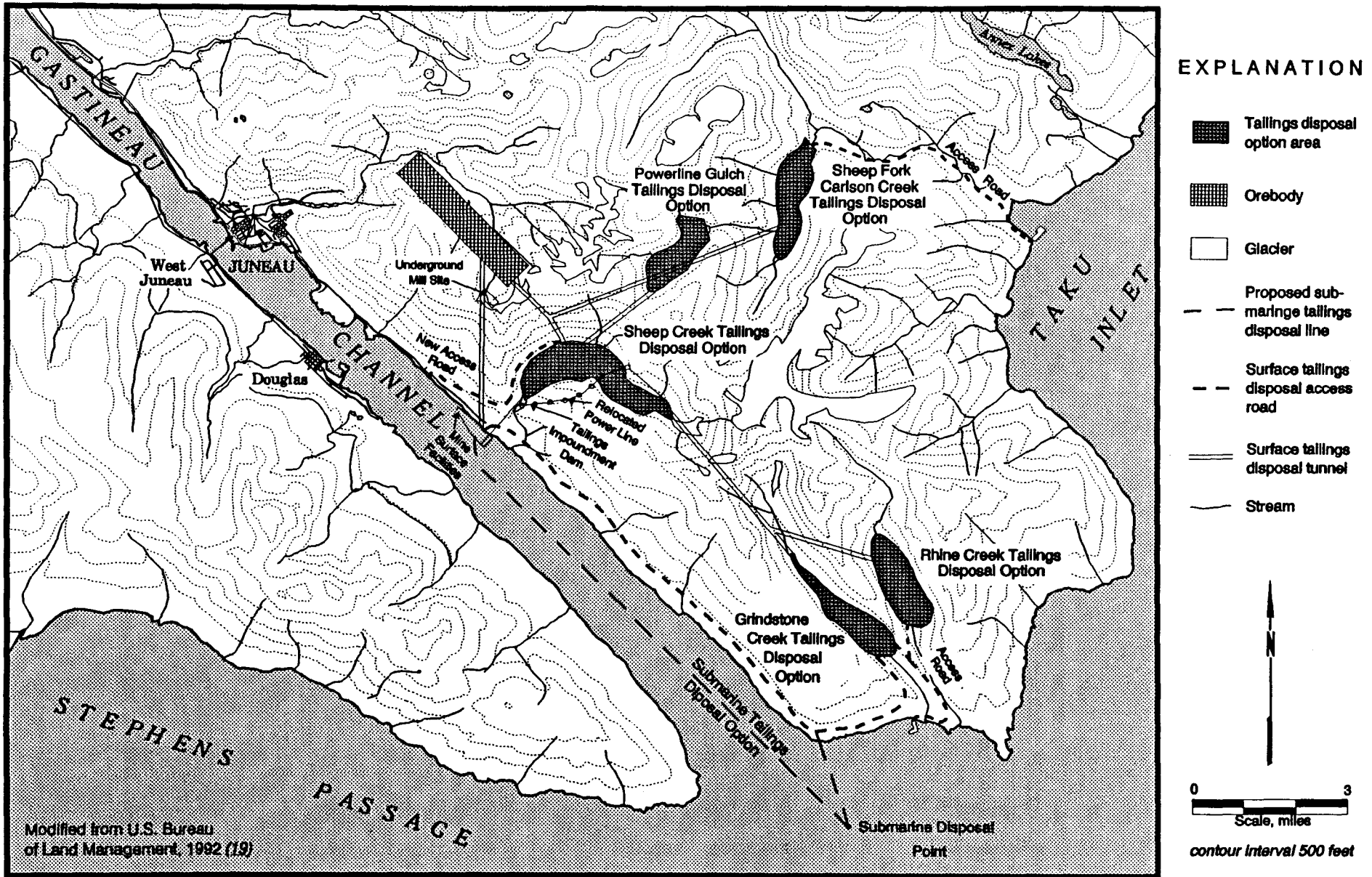

Figure 10. - Overview of Tailings Disposal Options Considered for AJ Mine.

development of literature on the subject, the Bureau signed a two-year cooperative agreement with the University of British Columbia to oversee the researching, writing, and technical review of a series of case studies of mines that have used submarine disposal techniques worldwide. Reports are due in 1992 and 1993. Concurrently, the Bureau's Spokane Research Center has begun an investigation of dissolution of minerals and reagents from tailings in freshwater and marine environments, and is currently evaluating other research directions (16).

BIBLIOGRAPHY

To provide a resource for those interested in the subject of STD, the Bureau developed a database listing approximately 1,500 documents. References cover the biological, chemical, environmental, and technical aspects of the subject. The bibliography contained in this report was generated from the database. The bibliography is available in digital form (PC compatible) in the WordPerfect® format.

METHODOLOGY

References were compiled from many sources, including periodicals, books, conference proceedings, government documents, and computerized databases. Each reference was assigned to a category based on the content of the document. In many instances, the category may not be entirely representative of the entire reference and some overlap does occur. Keywords were assigned to each reference to aid in searching. References were then entered into a computer database to allow sorting and retrieval by category, keyword, author, and other criteria. A program to format and print the information in the database was developed and used to generate the bibliography that follows.

FORMAT AND CONTENT

The database was designed to allow the entry of author(s), title, publisher, volume, number, year, pages, category, and keyword(s) for each reference. An attempt has been made to verify each entry, however there may be instances where not all information was available for each reference. Because of this, the bibliography should be considered a working document, rather than a formalized reference list.

The database contains 1,483 total references with the breakout by category as follows: Biological - 367 references, Chemical - 151 references, Environmental - 468 references, and Technical - 497 references. Technical references are those that did not easily fit into one of the other categories. Figure 11 shows the distribution of references by category.

The database was developed using a custom format; however the bibliography is available in the WordPerfect® format for those interested in searching or building their own database. The database can be obtained by writing the U.S. Bureau of Mines, Alaska Field Operations Center, P.O. Box 20550, Juneau, Alaska 99802, and supplying the necessary diskette.

The bibliography is presented in the appendix in an un-numbered format, with author(s) listed for each reference rather than replacing the name with underscores for succeeding works. This allows copying and rearranging of references by those readers who intend to manipulate the information using a word processor or database program.

Figure 11.- Distribution of STD References by Category.

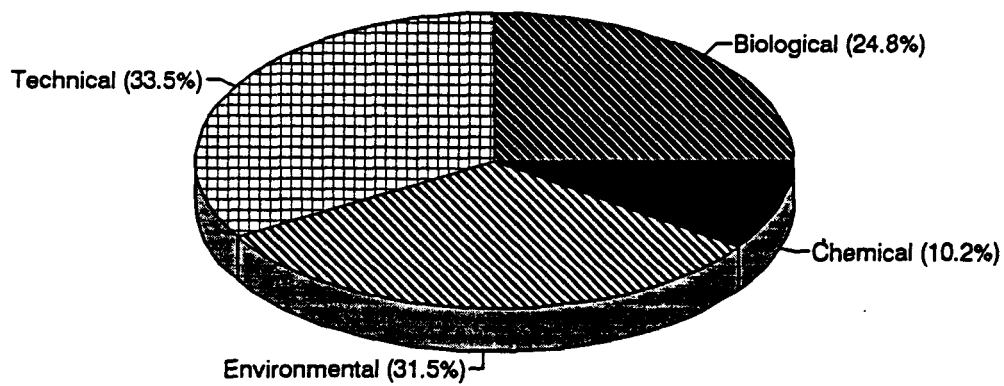

SUMMARY AND CONCLUSIONS

In summary, the Bureau of Mines has initiated a multi-year review of submarine tailings disposal technology. To date, work has been largely limited to reviewing the existing literature and discussions with private groups and government agencies knowledgeable on the subject. Conclusions to date are that specific literature is severely limited, scattered in many private reports, and incomplete. Significant problems have been encountered with some past submarine disposal operations, but indications are that the problems can be solved with current technology.

Even though submarine disposal of tailings from froth-flotation and cyanidation beneficiation processes is prohibited by regulation in the United States, other countries are taking advantage of the environmental and cost advantages provided by this technology. This may give mining operations in other countries a competitive advantage over United States producers in some cases.

As competition for land for mine waste disposal increases in coastal areas, consideration of marine disposal alternatives is on the rise. Results from the Bureau's review of existing literature and discussions with knowledgeable sources indicate that for select mineral deposits that have been rigorously investigated, a well designed submarine tailings-disposal system can be the preferred environmental alternative when compared to on-land disposal.

Approximately 1,500 references related to marine disposal of mine tailings have been collected. These are presented in the appendix and are available on diskette in the WordPerfect® format.

REFERENCES

1. Ellis, D. V., *Environments at Risk*, Springer-Verlag, New York, NY, 1989, 329 pp.
2. Ferguson, K. D., Manager, Mining and Metallurgy Program, Environment Canada, North Vancouver, B.C., personal communication, 1991.
3. Round Table Seminar on Submarine and Lake Disposal of Mill Tailings, Worldwide Industrial Mineral Processing Congress, XIV International Mineral Processing Congress, Toronto Ontario, Canada, October 17-23, 1982.
4. Ehrlich, H. L., *Biogenesis and Biodegradation of Sulfide Minerals on the Earth's Surface*, Chapter 15 in *Geomicrobiology*, Marcel Dekker, New York, NY, 1981, p. 281.
5. Salomons, W., and U. Förstner (Eds.), *Chemistry and Biology of Solid Waste*, Springer-Verlag, New York, NY, 1988, 305 pp.
6. Poling, G. W., *Characteristics of Mill Tailings and Their Behavior in Marine Environments*, in *Marine Tailings Disposal*, D. V. Ellis (Ed.), Ann Arbor Science, Ann Arbor, MI, 1982, pp. 63-84.
7. U.S. Department of Agriculture, Forest Service, *Final Environmental Impact Statement, Quartz Hill Molybdenum Project Mine Development*, 1988.

8. Trip Report on Travel to Vancouver-Vancouver Island, British Columbia, Canada, March 18-22, 1991. (Available upon request from Roger L. Baer, U.S. Bureau of Mines, P.O. Box 20550, Juneau, Alaska 99802.)
9. Poling, G. W., Professor of Mineral Process Engineering, University of British Columbia, Vancouver, B.C., personal communication, 1991.
10. Horne, I. A., Chief of Environmental Control, BHP-Utah Mines Ltd., Port Hardy, B.C., personal communication, 1992.
11. Ellis, D. V., Professor of Biology, University of Victoria, Victoria, B.C., personal communication, 1991.
12. Salomons, W., and U. Förstner (Eds.), Environmental Management of Solid Waste, Springer-Verlag, New York, NY, 1988, 396 pp.
13. Borell, S. C., Executive Director, Alaska Miners Association, Inc., Anchorage, AK, personal communication, 1991.
14. U.S. Environmental Protection Agency (EPA), "Final Decision of the Regional Administrator of EPA - Region 10, to deny the National Pollutant Discharge Elimination System (NPDES) Permit for Pacific Coast Molybdenum Company - Quartz Hill Project", 1990, 3 pp.
15. U.S. Department of Agriculture, Forest Service, Final Environmental Impact Statement, Kensington Gold Project, 1992.
16. Lambeth, R. H., Mining Engineer, U.S. Bureau of Mines, Spokane Research Center, Spokane, WA, personal communication, 1992.
17. Rescan Engineering Ltd., Preliminary Feasibility of Submarine Tailings Disposal, Kensington Project, Lynn Canal, Alaska, 1988.
18. Findikakis, A. N., Study of Submarine Tailings Disposal in Boca de Quadra - Appendix A: The Density Current/Sedimentation Mathematical Model, Bechtel Civil and Minerals, Inc. 1983.
19. U.S. Department of the Interior, Bureau of Land Management, Preliminary Final Environmental Impact Statement, A-J Mine Project, 1992.
20. U.S. Code of Federal Regulations. Title 40 - Protection of Environment; Chapter 1 - Environmental Protection Agency; Part 440 - Ore Mining and Dressing Point Source Category; July 1, 1989.

APPENDIX. -- BIBLIOGRAPHY

Biological Citations

- Abbott, O. J. The Toxicity of Ammonium Molybdate to Marine Invertebrates. *Mar. Pollut. Bull.*, v. 8, No. 9, 1977, pp. 204-205.
- Alaska Department of Fish and Game. Comparative Evaluation of the Fish and Wildlife Resource of Smeaton Bay and Boca de Quadra, Alaska. Southeast Reg. and Ketchikan Area Offices. Rep. Prepared for the U. S. Borax and Chem. Corp., 1980.
- Alino, P. M. The Effect of Mine Tailings on the Structure of Coral Communities at Toledo, Cebu. 3rd Symp. Our Environ., Singapore, 1984.
- Amy, P. S., B. A. Caldwell, A. J. Seldner, R. Y. Morita, and L. J. Albright. Microbial Activity and Ultrastructure of Mineral-Based Marine Snow From Howe Sound, British Columbia. *Can. J. Fish. Aquat. Sci.*, v. 44, 1987, pp. 1135-1142.
- Angel, M. V. Deep-Water Biological Processes in the Northwest Region of the Indian Ocean. *Deep-Sea Res.* 31 (6-8A), 1954, pp. 935-950.
- Asmangulyan, T. A. Maximum Permissible Concentration of Molybdenum in Water Basins From a Toxicological Point of View. *Trud. Erevansk. Med. Inst.*, 1963, v. A, No. 61, 1964, pp. 251-255.
- B. C. Research. Survey of the Marine Environment at Strathcona Sound. N.W.T., Aug. 1975, Prepared for Min. Resour. Int. Ltd., 1978.
- Barbaro, A., A. Francescon, B. Polo and M. Bilio. *Balanus Amphitrite* (Cirripedia: Thoracica) - A Potential Indicator of Fluoride, Copper, Lead, Chromium and Mercury in North Adriatic Lagoons. *Mar. Biol.*, v. 46, 1978, pp. 247-257.
- Barber, S., and J. H. Trefy. *Balanus Eburneus*: A Sensitive Indicator of Copper and Zinc Pollution in Coastal Zone. *Bull. Environ. Contam. Toxicol.*, v. 27, 1981, pp. 654-659.
- Bayne, B. L., M. N. Moore, J. Weddows, D. R. Livingstone, and P. Salkeld. Measurement of the Response of Individuals to Environmental Stress and Pollution: Studies with Bivalve Molluscs. *Phil. Trans. R. Soc. Lond. B.*, v. 286, 1979, pp. 563-581.
- Bell, M. C. Fisheries Handbook of Engineering Requirements and Biological Criteria: Useful Factors in Life History of Most Common Species. Unpublished Rep. Submitted to Fish. Eng. Res. Program. U.S. Army Corps of Eng., North Pac. Div. Portland, OR., 1973.
- Biak. A Preliminary Assessment of the Biological and Chemical Characteristics of Rupert Inlet, B. C. and Adjacent Waters. Rep. to Utah Constr. Min., 1970.
- Bjornn, T. C. Survival and Emergence of Trout and Salmon in Various Gravel-Sand Mixtures. Proc. of Forum on the Relation Between Logging and Salmon. Am. Inst. of Fish. Res. Board and AK. Dept. of Fish and Game, Juneau, 1968, pp. 80-88.
- Blackman, R. A. A., and K. W. Wilson. Effects of Red Mud on Marine Animals. *Mar. Pollut. Bull.*, v. 4, No. 11, 1973, 169-171.
- Bohn, A. Arsenic in Marine Organisms From West Greenland. *Mar. Pollut. Bull.*, v. 6, No. 6, 1975, pp. 87-89.
- Bohn, A., and R. O. McElroy. Trace Metals in Arctic Cod and Selected Zooplankton From Strathcona Sound, Baffin Island. *J. Fish. Res. Bd. Can.*, v. 33, 1976, pp. 3826-3840.

- Bollinberg, H. J., and P. Johnson. Lead in Spotted Wolfish, *Anarhichas Minor*, Near a Zinc-Lead Mine in Greenland. *J. Fish. Res. Bd. Can.*, v. 36, No. 9, 1979, pp. 1023-1028.
- Bookhout, C. G., R. Monroe, R. Forward, and J. D. Costlow, Jr. Effects of Soluble Fractions of Drilling Fluids and Hexavalent Chromium on the Development of the Crabs, *Rhithropanopeus Harrisii* and *Callinectes Sapidus*. EPA-600/S3-82-018, 1982.
- Borchardt, T. Influence of Food Quantity on the Kinetics of Cadmium Uptake and Loss via Food and Seawater in *Mytilus Edulis*. *Mar. Biol.*, v. 76, 1983, pp. 67-76.
- Boyden, C. R. Effect of Size Upon Metal Content of Shellfish. *J. Mar. Biol. Ass. U.K.*, v. 57, 1977, pp. 675-714.
- Brand, D. G., M. A. Farrell, and B. J. Reid. Preliminary Histological Assessment of Heavy Metal Accumulation in the Bivalve *Yoldia Thraciaeformis* Collected from Alice Arm, Hastings Arm and Satellite Channel, B. C. *Can. Manu. Rep. Fish. & Aquat. Sci. No. 1770*, Dep. of Fish. and Oceans, Canada, 1984.
- Breitmayer, J. P., G. N. Flatau, N. Zsurger. Comparative Effects of Size, Season, and Dose on Mercury and Cadmium Toxicity to Mussel *Mytilus Edulis* L. *Colloq. Inst. Natl. Sante Rech. Med. (Tests Toxic Aigue Milieu Aquat.)*, v. 106, 1982, pp. 407-413.
- Bright, D. A. The Histology of *Macoma Carlottensis* Whiteaves 1880 (Bivalvia: Tellinidae) and Histopathology Related to Mine Tailings Discharge. *Univ. Victoria M.Sc. Thesis*, 1987.
- Bright, D. A., and D. V. Ellis. Aspects of Histology in *Macoma Carlottensis* (Bivalvia: Tellinidae) and in Situ Histopathology Related to Mine Tailings Discharge. *J. Mar. Biol. Assoc. U. K.*, v. 69, No. 6, 1989, pp. 447-464.
- Brown, A. D., R. W. Gossett, P. Hershelman, and et al. Bioaccumulation and Detoxification of Contaminants in Marine Organisms from Southern California Coastal Waters. Ch. in *Waste Disposal in Oceans, Minimizing Impact, Maximizing Benefits*, ed. by D. F. Soule and D. Walsh, Westview, Boulder, CO., 1983.
- Brown, B. E., and A. Kumar. Temporal and Spatial Variations in Iron Concentrations of Tropical Bivalves During a Dredging Event. *Mar. Pollut. Bull.*, v. 21, No. 3, 1990, pp. 118-123.
- Brown, B. E., and L. S. Howard. Assessing the Effects of Stress on Reef Corals. *Adv. Mar. Biol.*, v. 22, 1985, pp. 1-63.
- Brown, D. A, E. M. Perkins, K. D. Jenkins, P. S. Oshida, S. M. Bay, J. F. Alfafara, and V. Raco. Seasonal Changes in Mussels. Ch. in *Coastal Water Res. Project, Biennial Rep. 1981-1982*, ed. by W. Bascom, 1982, pp. 179-192.
- Bryan, G. W. Some Aspects of Heavy Metal Tolerance in Aquatic Organisms. Ch. in *Effects of Pollut. on Aquat. Organisms*, ed. by A. P. M. Lockwood, Cambridge, 1976, pp. 7-34.
- Bryan, G. W. Adaptation of an Estuarine Polychaete to Sediments Containing High Concentrations of Heavy Metals. Ch. in *Pollut. and Physiol. of Mar. Organisms*, ed. by, F. J. Vernberg and W. B. Vernberg, Acad., 1974, pp. 123-135.
- Bryan, G. W. Bioaccumulation of Marine Pollutants. *Phil. Tran. R. Soc., London*, v. B, No. 286, 1979, pp. 397-633.
- Bryan, G. W. The Biological Availability and Effects of Heavy Metals in Marine Deposits. Program and Abstr., Third Intl. Ocean Disposal Symp., Woods Hole Oceanogr. Inst., Woods Hole, MA., 1981, pp. 25-26.
- Bryan, G. W. The Absorption of Zinc and Other Metals by the Brown Seaweed *Laminaria Digitata*. *J. of the Mar. Biol. Assoc. of the U.K.*, v. 49, No. 1, 1969, pp. 225-243.
- Bryan, G. W., and H. Vysal. Heavy Metals in the Burrowing Bivalve *Scrobicularia Plana* From the Tamar Estuary in Relations to Environmental Levels. *J. Mar. Biol. Ass., U. S.*, v. 58, 1978, pp. 89-108.
- Bryan, G. W., and L. G. Hummerstone. Adaptation of the Polychaete *Nereis Diversicolor* to Manganese in Estuarine Sediments. *J. of the Mar. Biol. Assoc. of the U.K.*, v. 53, No. 4, 1973, pp. 859-872.

- Bryan, G. W., and L. G. Hummerstone. Adaptation of the Polychaete *Nereis Diversicolor* to Estuarine Sediments Containing High Concentrations of Zinc and Cadmium. *J. Mar. Biol. Assoc., U. K.*, v. 53, 1973, pp. 839-857.
- Bryan, G. W., and L. G. Hummerstone. Brown Seaweed as an Indicator of Heavy Metal in Estuaries in Southwest England. *J. Mar. Biol. Ass., U. K.*, 1973, pp. 705-720.
- Bryan, G. W., and L. G. Hummerstone. Adaptation of the Polychaete *Nereis Diversicolor* to Estuarine Sediments Containing High Concentrations of Heavy Metals. I. General Observations and Adaptation to Copper. *J. Mar. Biol. Assoc. U. K.*, v. 51, No. 4, 1971, pp. 845-863.
- Bryan, G. W., G. W. Potts, and G. R. Forster. Heavy Metals in the Gastropod Mollusc (*Haliotis Tuberculata* L.). *J. Mar. Biol. Assoc. U. K.*, v. 57, 1977, pp. 379-390.
- Bryner, L. C. and R. Anderson. Microorganisms in Leaching Sulfide Minerals. *Ind. Eng. Chem.*, 1957, 43 pp.
- Bryner, L. C., and A. K. Jameson. Microorganisms in Leaching Sulfide Minerals. *Appl. Microbio.*, v. 6, 1958, pp. 281-287.
- Buck, E. H. Comparative Assessment: Fisheries Resources of Wilson Arm (Smeaton Bay) and the Head of Boca de Quadra. *Univ. of AK, Anchorage, Arctic Environ. Inf. and Data Cent.*, 1976.
- Bussarawich, S., A. Nateewathana, and J. Hylleberg. Distribution of Marine Benthic Amphipods off Phuket Island, with Emphasis on Tin Mining and a Model of Species-Individual Relationships. *Phuket Mar. Biol. Cent., Res. Bull.* 32, 1984, 21 pp.
- Byers, S. C., B. J. Reid, M. A. Farrell. Stomach Contents of Crabs and Bottomfish from Alice Arm, Hastings Arm, Observatory Inlet and Nass River, B. C., October 1983. *Can. Manu. Rep. Fish. & Aquat. Sci. No. 1771*, Dep. of Fish. and Oceans, Canada, 1984.
- Calabrese, A., J. R. MacInnes, D. A. Nelson, R. A. Greig, and P. P. Yevich. Effects of Long-Term Exposure to Silver or Copper on Growth, Bioaccumulation, and Histopathology in the Blue Mussel *Mytilus Edulis*. *Mar. Environ. Res.*, v. 11, 1984, pp. 253-274.
- Calvin, N. I. A Qualitative Description of the Intertidal Plants and Animals of Berners Bay, Southeastern Alaska. Thesis, v. 10, 1977, pp. 11-24.
- Campbell, R. A. Avoidance-Behavior Bioassay. Ch. in *Trident Dredging Study: The Effects of Dredging at the U.S. Naval Submarine Base at Bangor on Migrating Juvenile Chum Salmon, Oncorhynchus Keta*, In Hood Canal, WA. *Univ. of WA. FRI-UW-7918*, 1979, pp. 106-169.
- Chang, B. D. Laboratory Experiments on the Effects of Ocean Dumping on Benthic Invertebrates, Effects of Burial on the Heart Cockle, and the Dungeness Crab. *Pac. Environ. Inst.*, v. 17, 1976.
- Chang, B. D., and C. D. Levings. Laboratory Experiments on the Effects of Ocean Dumping on Benthic Invertebrates, 1. Choice Tests With Solid Wastes. *Tech. Rep. Fish. Mar. Serv. Res. Dev.*, No. 637, 1976.
- Chapman, P. M. The Effects of Gut Sediment Contents on Measurements of Metal Levels in Benthic Invertebrates - a Cautionary Note. *Bull. Environ. Contam. Toxicol.*, v. 35, 1984, pp. 345-347.
- Chapman, P. M., and E. R. Long. The Use of Bioassays as Part of a Comprehensive Approach to Marine Pollution Assessment. *Mar. Pollut. Bull.*, 1983.
- Chapman, P. M., and R. O. Brinkhurst. Lethal and Sublethal Tolerances of Aquatic Oligochaetes with Reference to Their Use as a Biotic Index of Pollution. *Devel. in Hydrobiol.*, 1983.
- Chapman, P. M., G. A. Vigers, M. A. Farrell, R. N. Dexter, E. A. Quinlan, R. M. Kocan, and M. Landolt. Survey of Biological Effects of Toxicants Upon Puget Sound Biota: I. Broad-Scale Toxicity Survey. *NOAA Tech. Memorandum OMPA-25*, 1982.

- Chapman, P. M., L. M. Churchland, P. A. Thomason, and E. Michnowsky. Heavy Metals Studies with Oligochaetes. Ch. in *Aquat. Oligochaete Biol.*, ed. by R. O. Brinkhurst and D. G. Cook, Plenum, 1980.
- Chapman, P. M., M. A. Farrell, and R. O. Brinkhurst. Effects of Species Interactions on the Survival and Respiration of *Limnodrilus Hoffmeisteri* and *Tubifex Tubifex* (Oligochaeta, Tubificidae) Exposed to Various Pollutants and Environmental Factors. *Water Res.*, v. 16, 1982, pp. 1405-1408.
- Cimberg, R. L. Marine Tailings Recolonization Studies in Southeast Alaska. Sixth Int. Ocean Disp. Symp. Asilomar, CA., 1986.
- Clarke, R. McV. The Effects of Effluents From Metal Mines on Aquatic Ecosystems in Canada. Tech. Rep., Fish. and Mar. Services, Environ. Canada, No. 488, 1974.
- Cobb, D. A. Effects of Suspended Solids on Larval Survival of the Eastern Lobster, *Homarus Americanus*. Preprint 8th Annu. Conf. and Expos. Mar. Tech. Soc., Appl. of Mar. Tech. to Human Needs, 1972, pp. 395-402.
- Collett, L. C., A. J. Collins, P. J. Gibbs, and R. J. West. Shallow Dredging as a Strategy for the Control of Sublittoral Macrophytes: A Case Study in Tuggerah Lakes, New South Wales. *Aust. J. Mar. Freshwater Res.*, v. 32, 1981, pp. 563.
- Collier, R. W., and J. M. Edmond. Plankton Compositions and Trace Element Fluxes From the Surface Ocean. Ch. in *Trace Metals in Seawater*, ed. by C. S. Wong, et al, NATO Sci. Affairs Div., Plenum, 1983, pp. 789-809.
- Connor, P. M. Acute Toxicity of Heavy Metals to Some Marine Larvae. *Mar. Pollut. Bull.*, v. 3, 1972, pp. 190-192.
- Coombs, T. L., and S. G. George. Mechanisms of Immobilization and Detoxification of Metals in Marine Organisms. Ch. in *Physiol. and Behavior of Mar. Organisms*, ed. by D. J. McLusky and A. J. Berry, Pergamon, 1978, pp. 179-187.
- Cotter, A. J. R., D. J. H. Phillips, and M. Ahsanullah. The Significance of Temperature, Salinity and Zinc as Lethal Factors for the Mussel, *Mytilus Edulis*, in a Polluted Estuary. *Mar. Biol. (Ber.)*, v. 68, No. 2, 1982, pp. 135-141.
- Craig, P. J., and J. Wood. The Biological Methylation of Lead: An Assessment of the Present Position. Ch. in *Environ. Lead- Proc. Int. Symp., Environ.- Mental Lead Res., Dredged-Mater. Disposal in the Ocean*, ed. by D.R. Kester, B.H. Ketchum, I.W. Duedall, and P.K. Parks, 1983, pp. 173-184.
- Cross, F. A. and W. G. Sunda. Relationship Between Bioavailability of Trace Metals and Geochemical Processes in Estuaries. Ch. in *Estuarine Interactions*, ed. by M. L. Wiley, Acad., 1978.
- Dehtlefsen, V. Occurrence and Abundance of Some Skeletal Deformities, Diseases, and Parasites of Major Fish Species in Dumping Areas off the German Coast. *Int. Council for Expl. of the Sea (C. M. Papers and Rep.)*, v. E, No. 8, 1987, 17 pp.
- Dempsey, J. Oceanographic and Marine Biological Surveys in Alice Arm and Hastings Arm, British Columbia, Heavy Metal Content of Crabs Taken in Alice Arm and Hastings Arm. Dobrocky Seatech Ltd. for Dr. J. L. Littlepage, Program Director, Alice Arm Surv., 1977.
- Deniseger, J., L. Erickson, A. Austin, M. Roch, and M. J. R. Clark. The Effects of Decreasing Heavy Metal Concentrations on the Biota of Buttle Lake, Vancouver Island, B. C. *Water Res.*, v. 24, No. 4, 1990, pp. 404-416.
- Denny, P., and R. P. Welsh. Lead Accumulation in Plankton Blooms From Ullswater, the English Lake District. *Environ. Pollut.*, v. 18, No. 1, 1979, pp. 1-9.
- Denton, G. R. W., and W. G. Breck. Mercury in Tropical Marine Organisms From North Queensland. *Mar. Pollut. Bull.*, v. 12, No. 4, 1981, pp. 116-121.
- Dixon, D. G., and J. B. Sprague. Copper Bioaccumulation and Hepatoprotein Synthesis During Acclimation to Copper by Juvenile Rainbow Trout. *Aquat. Toxicol.*, v. 1, 1981, pp. 69-81.

- E.V.S. Consultants. Draft Interim Report on Acute, Chronic and Sublethal Bioassays and Bioaccumulation Studies. 1984.
- E.V.S. Consultants. Report on Acute Lethal Marine Bioassay Studies for the U. S. Borax Quartz Hill Project with Appendix A. Prepared for Bechtel Civil & Min., Inc., 1984.
- Eagle, G. A. The Sublethal Effects of Some Trace Metals, Particularly Cadmium, Copper, Mercury and Lead, on Various Marine Organisms. CSIR Res. Rep., No. 382, 1980.
- Ehrlich, H. L. Biogenesis and Biodegradation of Sulfide Minerals on the Earth's Surface. Ch. in Geomicrobiol., ed. by H. L. Ehrlich, and M. Dekker, 1981, pp. 281-298.
- Eisler, R. Behavioural Responses of Marine Poikilotherms to Pollutants. Phil. Trans. R. Soc. Lond. B., v. 286, 1979, pp. 507-521.
- Eisler, R. Trace Metal Concentrations in Marine Organisms. Pergamon, 1982.
- Eisler, R., and Garton. One of Ten Heavy Metals in Sea Water. J. Water Pollut. Control Fed., v. 51, 1979, pp. 2545.
- Eldon, J., M. Pekkarinen, and R. Kristoffersson. Effects of Low Concentrations of Heavy Metals on the Bivalve *Macoma Bathica*. Annals Zoologici Fennici, v. 17, 1980, pp. 233-242.
- Elliot, S. T. Baseline Biological Investigation of Aquatic Macrobenthos and Juvenile Salmonids in Relation to the Proposed U. S. Borax Molybdenum Mine Near the Keta and Blossom Rivers, 1978-1979. AK. Dep. of Fish and Game. Spec. Rep., 1980.
- Ellis, D. V. Priorities for Marine Developments in Artificial Substrate Bioassays: Symposium Comment. Ch. in Artificial Substrates, ed. by J. Cairns, Ann Arbor Science, 1982, pp. 267-276.
- Ellis, D. V. Metal Levels in Bivalve Mollusks, March, 1974, With a Review of Biological Metal Level Statistical Procedures. Rep., Independent Monitoring Group of UBC For Island Copper Mines, 1975.
- Ellis, D. V. Ecologically Significant Species in Coastal Marine Sediments of Southern British Columbia. Syesis, v. 2, 1969, pp. 171-182.
- Ellis, D. V. Report on Benthic Identification Services. Rep. to Utah Mines Ltd., 1986, 10 pp.
- Ellis, D. V. Turbidity Reviews IV Dungeness Crab. Literature Review Rep. to the UBC Ind. Mon. Group for ICM, 1975, 12 pp. plus appendices.
- Ellis, D. V. Preliminary SEM Examination of Biological Tissue for Mine Tailing. Rep. to Island Copper Mine, 1979, 7 pp.
- Ellis, D. V. The Benthos Survey 1986. Rep. Univ. Victoria Res. Contr. Island Copper Mine, 1987, 27 pp.
- Ellis, D. V. and L. Bissel. A Preliminary Report on Increasing Copper Levels in Intertidal Clams Near Island Copper Mine. Rep. to Island Copper Mine in Appendix 3 to Island Copper Mine, Sum. Rep. Second Prod. Year, Oct. 1972-Sep. 1973, Environ. Control Program, Univ. of B. C., 1974.
- Ellis, D. V., and A. A. Jones. Alice Arm Project, Review of Benthic Infauna Data. Rep. to Dr. J. L. Littlepage, Univ. of Victoria, B. C., 1975, 28 pp.
- Ellis, D. V., and G. C. Jewsbury. Turbidity Reviews III, Pacific Salmon-Literature Survey and Population Data. Rep. UBC Independent Monitoring Group for Island Copper Mine, 1974.
- Ellis, D. V., and K. E. Conlan. Defining Species Associations for Pollution Assessment. Can. Res., v. 15, 1979.
- Ellis, D. V., and P. M. Hoover. Benthos in Tailings Beds From an Abandoned Coastal Mine. Mar. Pollut. Bull., v. 21, No. 10, 1990, pp. 477-480.

- Ellis, D. V., and P. M. Hoover. Benthos Recolonising Mine Tailings in British Columbia Fjords. *Mar. Min.*, 1991.
- Ellis, D. V., and S. F. Cross. A Protocol for Inter-Laboratory Calibrations of Biological Species Identifications (Ring Tests). *Water Res.*, v. 15, 1981, pp. 1107-1108.
- Ellis, D. V., P. Gee, and S. Cross. Recovery from Zinc Contamination in a Stock of Pacific Oysters, *Crassostrea Gigas* Tunberg. *Water Pollut. Res. J. of Can.*, v. 15, No. 4, 1981, pp. 303-310.
- Ellis, D.V. Oceanographic and Marine Biological Surveys in Alice Arm and Hastings Arm, B.C., Benthic Infauna of Alice Arm and Hastings Arm, B. C., Appendix 1 - Review of Benthic Infauna Data. Dobrocky Seatech Ltd. for Dr. J. L. Littlepage, Oceanogr. Consultant and Program Director, Alice Arm, 1975.
- Elson, P. F., L. N. Lauzier, and V. Zitko. A Preliminary Study of Salmon Movements in a Polluted Estuary. Ch. in *Mar. Pollut. and Sea Life*, ed. by M. Ruivo, Food and Agric. Org. of the United Nations (FAO), 1973, pp. 325-330.
- Engel, D. W., and B. A. Fowler. Copper and Cadmium Induced Changes in the Metabolism and Structure of Molluscan Gill Tissue. Ch. in *Mar. Pollut.: Functional Responses*. Vernberg, ed. by F. J. et al. Pergamon, 1979, pp. 239-256.
- Environmental Protection Agency. Bioassay Procedures for the Ocean Disposal Permit Program. *Environ. Res. Lab.*, Gulf Breeze, FL, EPA-600/9-78-010, 1978.
- Erasmus, T., and A. F. DiVilliers. Ore Dust Pollution and Body Temperatures of Intertidal Animals. *Mar. Pollut. Bull (G.B.)*, v. 13, 1982, pp. 283.
- European Inland Fisheries Advisory Commission. Water Quality Criteria for European Freshwater Fish. *Water Res.*, v. 7, 1973, pp. 1011-1022.
- European Inland Fisheries Commission. Water Quality Criteria for Environmental Freshwater Fish. *Tech. Paper 43*. Food and Agric. Org. of the United Nations, 1983, 32 pp.
- EVS (ed.). Report on Acute, Chronic and Sublethal Bioassays and Bioaccumulation Studies. Rep. U.S. Borax, 1984, 46 pp. and Appendices.
- EVS (ed.). Report on Acute Lethal Marine Bioassay Studies for the US Borax Quartz Hill Project. Rep. Bechtel Group, 1984, 34 pp and Appendices.
- Farrell, M. A., and M. D. Nassichuk. Trace Metal Levels in Bivalves and Crabs From Alice Arm, Hastings Arm and Observatory Inlet, B. C. *Can. Data Rep. Fish. Aquat. Sci.*, No. 467, 1984.
- Flemer, D. A., W. C. Dovel, H. J. Pfitzenmeyer, and D. E. Ritchie JR. Spoil Disposal in Upper Chesapeake Bay: II - Preliminary Analysis of Biological Effects. Ch. in *Natl. Symp. on Estuarine Pollut., Proc.*, ed. by P. L. McCarty, and R. Kennedy, Stanford Univ., 1967, pp. 152-187.
- Foell, E. J., and D. L. Pawson. Photographs of Invertebrate Megafauna From Abyssal Depths of the Northeastern Equatorial Pacific Ocean. *Ohio J. Sci.*, v. 86, No. 3, 1986, pp. 61-68.
- Foell, E. J., H. Thiel, and G. Schriever. DISCOL: A Long-Term, Large-Scale, Disturbance-Recolonization Experiment in the Abyssal Eastern Tropical South Pacific Ocean. *Pres. at 22nd Annu. OTC*, Houston TX. OTC 6328, May 7-10, 1990, pp. 407-503.
- Foreman, R. E. June Reconnaissance of Benthic Sublittoral Communities in Rupert and Holberg Inlets. Rep. Island Copper Mine, 1974, 24 pp.
- Fries, C. R., and M. R. Tripp. Cytological Damage in *Mercenaria* Exposed to Phenol. Ch. in *Fate and Effects of Petroleum Hydrocarbons in Marine Organisms and Ecosystems*, ed. by D. A. Wolfe, Pergamon, 1977, pp. 174-181.
- Fujiya, M. Studies on the Effects of the Tailing of Flotation Process to the Coastal Organisms. *Bull. Jap. Soc. Sci. Fish.*, v. 26, No. 10, 1960.

- Galloway, W. B., J. L. Lake, et al. The Mussel Watch: Intercomparison of Trace Level Constituent Determinations. *Environ. Toxicol. Chem.*, v. 2, 1983, pp. 395-410.
- Gee, P. A., and D. V. Ellis. Collated Marine Toxin Data. Rep., Biol. Dep., Univ. Victoria, B. C., No. 10, 1981.
- Ginn, T. C., and R. C. Barrick. Bioaccumulation of Toxic Substances in Puget Sound Organisms. *Fifth Intl. Ocean Disp. Symp.*, Corvallis, OR., 1984.
- Giraud, A. S., L. K. Webster, J. G. Fabris, L. C. Collett, and N. D. Yeomans. Absence of Histopathological Response to Cadmium in Gill and Digestive Diverticula of the Mussel, *Mytilus edulis*. *Bull. Environ. Contam. Toxicol.*, v. 36, 1986, pp. 146-149.
- Goddard, J. G. A Qualitative Species List of Intertidal Macroflora and Macrofauna Near the Former Mine Tailings Discharge Pipe at Jordan River, B. C. Dobrocky Seatech Ltd., 1975, 11 pp.
- Goldberg, E. D. The Mussel Watch--A First Step in Global Marine Monitoring. *Mar. Pollut. Bull.*, v. 6, No. 7, 1975, pp. 111.
- Goldberg, E. D., and J. H. Martin. Metals in Seawater as Recorded by Mussels. Ch. in *Trace Metals in Seawater*, ed. by C. S. Wong, et al, NATO Sci. Affairs Div., Plenum, 1983, pp. 811-823.
- Grassle, J. F. Hydrothermal Vent Animals: Distribution and Biology. *Science*, v. 229, No. 4715, 1985, pp. 713-717.
- Grassle, J. F. Animals in the Soft Sediments Near the Hydrothermal Vents. *Oceanus*, v. 27, No. 3, 1984, pp. 63-66.
- Gray, J. S. *The Ecology of Marine Sediments*. Cambridge Univ., 1981.
- Gray, J. S. Pollution-Induced Changes in Populations. *Phil. Trans. R. Soc. Lond. B.*, v. 286, 1979, pp. 545-561.
- Gray, J. S., and F. B. Mirza. A Possible Method for the Detection of Pollution-Induced Disturbance on Marine Benthic Communities. *Mar. Pollut. Bull.*, v. 10, 1979, pp. 142-146.
- Gray, J. S., and T. H. Pearson. Objective Selection of Sensitive Species Indicative of Pollution-Induced Change in Benthic Communities. I. Comparative Methodology. *Mar. Ecol. Prog. Ser.*, v. 9, 1982, pp. 111-119.
- Grice, G. D., P. H. Wiebe, and W. Hoagland. Acid - Iron Waste as a Factor Affecting the Distribution and Abundance of Zooplankton in the New York Bright. *Estuarine and Coastal Mar. Sci.*, 1973, pp. 45-50.
- Gutierrez - Galindo, E. A., and J. Ph. Breitmayer. Effect of Zinc on Mercury Accumulation by the Common Mussel. *Revue Int. Oceanogr. Med.*, v. 63/64, 1981, pp. 97-102.
- Hallman, R., R. Kussat, and M. Jones. A Biological Assessment of Benson Lake Following Cessation of Deep Lake Tailings Disposal. *Environ. Can. Pac.; Reg., Surveillance Rep. EPS 5-PR-74-2*, 1974, 16 pp.
- Halstead, B. W. Toxicity of Marine Organisms Caused by Pollutants. Ch. in *Mar. Pollut. and Sea Life*, ed. by M. Ruivo, Fishing News (Books) Ltd., England, 1973, pp. 584-594.
- Hannan, C. A., L. W. Hulberg, K. M. Mawn, M. G. Kellogg, and J. W. Nybakken. Life History Analyses of Marine Benthic Invertebrates. *CA State Water Resour. Control Board*, No. 63, 1979.
- Harris, P. O., and G. J. Ramelow. Binding of Metal Ions by Particulate Biomass Derived from *Chlorella Vulgaris* and *Scenedesmus Quadricauda*. Ch. in *Environ. Sci. and Technol.*, Am. Chem. Soc., Washington, D.C., v. 24, No. 2, 1990, pp. 220-228.
- Harrison, F. L. Effect of Physicochemical Form on Copper Availability to Aquatic Organisms. Ch. in *Aquat. Toxicol. and Hazard Assess.*, Seventh Symp., ed. by R.D. Cardwell, R. Purdy, and R.C. Bahner, ASTM STP 854. Am. Soc. for Testing and Mater., Philadelphia, PA., 1985, pp. 469-484.

- Harrison, F. L., J. R. Lam, and R. Berger. Sublethal Responses of *Mytilus edulis* to Increased Dissolved Copper. *Sci. Total Environ.*, v. 28, 1983, pp. 141-158b.
- Harrison, P. J., J. D. Fulton, F. J. R. Taylor, and T. R. Parsons. Review of the Biological Oceanography of the Strait of Georgia: Pelagic Environment. *Can. J. Fish. Aquat. Sci.*, v. 40, 1983, pp. 1064-1094.
- Healey, M. C. Detritus and Juvenile Salmon Production in the Nanaimo Estuary: I. Production and Feeding Rates of Juvenile Chum Salmon. *J. of the Fish. Res. Board of Canada*, v. 36, 1979, pp. 488-496.
- Heitmuller, P. T., T. A. Hollister, and P. R. Parrish. Acute Toxicity of 54 Industrial Chemicals to Sheepshead Minnows (*Cyprinodon Variegatus*). *Bull. Environ. Contam. Toxicol.*, v. 27, 1981, pp. 596-604.
- Herbert, D. W. M., and A. C. Wakeford. The Susceptibility of Salmonids Fish to Poisons Under Estuarine Conditions - I. Zinc Sulphate. *Int. J. Air Water Pollut.*, v. 8, 1964, pp. 215-256.
- Hirota, J. Potential Effects of Deep-sea Minerals Mining on Macrozooplankton in the North Equatorial Pacific. *Mar. Min.*, v. 3, No. 1-2, 1981, pp. 19-57.
- Hirsch, N. D., L. H. DiSalvo, and R. Peddicord. Effects of Dredging and Disposal on Aquatic Organisms. Tech. Rep. DS-78-5, U.S. Army Eng. Waterways Experiment Station, Vicksburg, MS., 1978.
- Hollister, T. A., P. T. Heitmuller, P. R. Parrish, and E. E. Dyar. Studies to Determine Relationships Between Time and Toxicity an Acidic Effluent and an Alkaline Effluent to Two Estuarine Species. Ch. in *Aquat. Toxicol., ASTM STP 707*, ed. by J. G. Eaton, P. R. Parrish and A. C. Hendricks, 1980, pp. 251-265.
- Hu, V. J. H. Ingestion of Deep-Sea Mining Discharge by Five Species of Tropical Copepods. *Water, Air, and Soil Pollut.*, v. 15, 1981, pp. 433-440.
- Hughes, J. R., W. E. Ames, D. A. Misitano, and G. F. Slusser. Aquatic Disposal Field Investigations, Duwamish Waterway Disposal Site, Puget Sound, Washington. Appendix A. Effects of Dredged Material Disposal on Demersal Fish and Shellfish in Elliott Bay, Seattle, WA. *Natl. Mar. Fish. Service, Mukilteo, WA. Northwest and AK. Fish. Cent., WES-TR-D-77-24-APP-A*, 1978.
- Humason, G. L. *Animal Tissue Techniques*. London, Freeman, 1979.
- Hung, T. C., C. Y. Kuo, and M. H. Chen. Mussel Watch in Taiwan, Republic of China (1) Bioaccumulative Factors of Heavy Metals. *Acta. Oceanogr. Taiwan*, v. 12, 1981, pp. 67-83.
- Hurme, A. K., and E. J. Pullen. Biological Effects of Marine Sand Mining and Fill Replacement for Beach Replenishment: Lessons For Other Uses. *Mar. Min.*, v. 7, No. 2, 1988, pp. 123-136.
- Hvilsom, M. M. Copper-induced Differential Mortality in Mussel (*Mytilus edulis*). *Mar. Biol.*, v. 76, 1983, pp. 291-295.
- Hylleberg, J., A. Nateewathana, and B. Chatanathawej. Effects Offshore Tin Mining on Macro-Benthos on the West Coast of Phuket Island, The Andaman Sea, Thailand. Paper Pres. at the 15th Pac. Sci. Conf., Feb. 1-11, 1983, 25 pp. + tables and figures.
- Ibragim, A. M., and S. A. Patin. Effect of Mercury, Lead, Cadmium, and Copper on Primary Production and Phytoplankton in Some Coastal Regions of the Mediterranean and Red Seas. *Oceanology*, v. 15, 1976, 589-591.
- International Council for the Exploration of the Sea. Report of the Working Group on Effects on Fisheries of Marine Sand and Gravel Extraction. *Coop. Res. Rep.*, No. 46, 1975.
- Jacobs, F., and G. C. Grant. Guidelines for Zooplankton Sampling in Quantitative Baseline and Monitoring Programs. EPA-600/3-78-026, 1978.
- Jenkins, K. D., D. S. Brown, and P. Oshida. Detoxification of Metals in Sea Urchins. Ch. in *Coastal Water Res. Project, Biennial Rep. 1981-1982*, ed. by W. Bascom, 1982, pp. 173-178.

- Jenne, E. A., and S. M. Luoma. Forms of Trace Elements in Soils, Sediments, and Associated Waters: An Overview of Their Determination and Biological Availability. Ch. in *Biol. Implications of Met. in the Environ.*, ed. by H. Drucker and R.E. Wildung, Tech. Inform. Cent., Energy Res. & Devel. Adm., Symp. Ser. 42, 1977, pp. 110-143.
- Johansen, P., M. M. Hanson, and G. Asmund. Marine Organisms as Indicators of Heavy Metal Pollution - Experienced from 16 Years of Monitoring Heavy Metals at Zinc Lead Mine in Greenland. *Greenland Environ. Res. Inst.*, 1989, pp. 72.
- Johnson, D. W., and D. J. Wildish. Avoidance of Dredge Spoils by Herring (*Clupea harengus harengus*). *Bull. Environ. Contam. Toxicol.*, v. 26, 1981, pp. 307-314.
- Johnston, J. B., and D. M. Hartley. Bivalves as Monitors for Persistent Pollutants in Marine and Freshwater Environments. Ch. in *Environ. Toxicol. Principles and Policies*, ed. by S. M. Somani, & F. L. Cavender, C. C. Thomas, Springfield, IL, 1981.
- Jokiel, P. L. Effects of Marine Mining Dredge Spoils on Eggs and Larvae of a Commercially Important Species of Fish, The Mahimahi (*Coryphaena Hippurus*). *Mar. Min.*, v. 8, No. 3, 1989, pp. 303-316.
- Jones & Stokes Associates, Inc. Review of Toxic Effects of Copper, Zinc, Lead, Iron, Molybdenum and Sulfur on Salmonid Fishes. Sacramento, CA., 1976.
- Jones, A. A. Effects of Mine Tailings on Benthic Infaunal Composition in a British Columbia Inlet: With Special Reference to Sampling, Instrumentation, and the Biology of *Ammotypane Aulogaster* (Polychaeta, Ophelidae). M.Sc. Thesis, Univ. of Victoria, B. C., 1974.
- Jones, A. A., and D. V. Ellis. Sub-Obliterative Effects of Mine-Tailings on Marine Infaunal Benthos II. Effect on the Productivity of *Ammotypane Aulogaster*. *Water, Air and Soil Pollut.*, v. 5, 1976, pp 299-307.
- Jones, G., and S. Candy. Effect of Dredging on Macrobenthic Infauna of Botany Bay. *Aust. J. Mar. Freshwater Res.*, v. 32, 1981, pp. 379.
- Karickhoff, S. W., and K. R. Morris. Impact of Tubificid Oligochaetes on Pollutant Transport in Bottom Sediments. *Environ. Sci. Technol.*, v. 19, 1985, pp. 51.
- Kathman, R. D., R. O. Brinkhurst, R. E. Woods, and D. C. Jeffries. Benthic Studies in Alice Arm and Hastings Arm, B. C. in Relation to Mine Tailings Disposal. *Can. Tech. Rep. Hydrog. Ocean Sci.*, v. 22, 1983, 30 pp.
- Kathman, R. D., R. O. Brinkhurst, R. E. Woods, and S. F. Cross. Benthic Studies in Alice Arm, B. C. Following Cessation of Mine Tailings Disposal. *Can. Tech. Rep. Hydrog. Ocean Sci.*, v. 37, 1984, 57 pp.
- Kenaga, E. E., and C. A. I. Goring. Relationship Between Water Solubility, Soil Sorption, Octanol-water Partitioning, and Concentration of Chemical in Biota. Ch. in *ASTM*, ed. by J. G. Eaton, P. R. Parrish, and A. C. Hendricks. Philadelphia, PA. ASTM STP 707, 1980, pp. 78-115.
- Kiorboe, T., E. Frantsen, C. Jensen, and G. Sorensen. Effects of Suspended Sediment on Development and Hatching of Herring (*Clupea Harengus*). *Eggs, Estuarine, Coastal and Shelf Sci.*, v. 13, 1981, pp. 107-111.
- Kitasaki, K. Effects of Suspended Sediments on Pacific Herring. 1986.
- Kleinman, R. L. P., D. A. Crerar, and R. R. Pacelli. Biogeochemistry of Acid Mine Drainage and a Method to Control Acid Formation. *Min. Eng.*, 1981, pp. 300-305.
- Knauer, G. A., and J. H. Martin. Seasonal Variations of Cadmium, Copper, Manganese, Lead and Zinc in Water and Phytoplankton in Monterey Bay, California. *Limnol. Oceanogr.*, v. 18, 1973, pp. 597-604.
- Knutzen, J. Effects of Decreased pH on Marine Organisms. *Mar. Pollut. Bull.*, v. 12, 1981, pp. 25-29.
- Kraft, K. L. *Pontoporeia* Distribution Along the Keweenaw Shore of Lake Superior Affected by Copper Tailings. *J. Great Lakes Res.*, v. 5, 1979, pp. 28-35.

Kraft, K. L., and R. H. Sypniewski. Effect of Sediment Copper on the Distribution of Benthic Macroinvertebrates in the Keweenaw Waterway. *J. Great Lakes Res.*, v. 7, 1981, pp. 258-263.

Langlois, D., R. J. Cooper, N. H. Clark, and D. A. Ratkowsky. The Effect of a Mercury Contaminant Programme at a Zinc Smelting Plant on the Mercury Content of Sand Flathead in the Derwent Estuary. *Mar. Pollut. Bull.*, v. 18, No. 2, 1987, pp. 67-70.

Leclerc, E. and F. Devlaminck. Nature of Synthetic Detergents and Fish. *Bull. Cen. Belge et. Document. Eaux*, v. 17, 1952, 165 pp.

Lee, C. R., R. M. Smart, T. C. Sturgis, R. N. Gordon Sr., and M. C. Landin. Prediction of Heavy Metal Uptake by Marsh Plants Based on Chemical Extraction of Heavy Metals From Dredged Material. *Tech. Rep. D-78-6*, U. S. Army Eng. Waterway Experiment Station, Environ. Effects Lab., 1978.

Lee, G. F. Chemical Aspects of Bioassay Techniques for Establishing Water Quality Criteria. *Water Res.*, v. 7, 1973, pp. 1525-1546.

Lee, G. F., and D. W. Anderson. The Effect of Taconite Tailings on Primary Productivity in the Silver Bay Area of Western Lake Superior. *Environ. Intern.*, v. 2, No. 1, 1979, pp. 13-17.

Lee, H. Monitoring Pollution with Marine Organisms. *Chem. Week*, 1982, pp. 57.

Levine, H. G. The Use of Seaweeds for Monitoring Coastal Waters. Ch. in *Algae as Ecol. Indicators*, Acad., 1984.

Levings, C. D. Benthic Biology of a Dissolved Oxygen Deficiency event in Howe Sound, B. C. Ch. in *Fjord Oceanogr.*, ed. by H. J. Freeland, et al. Plenum, 1980, pp. 512-522.

Levings, C. D. Demersal and Benthic Communities in Howe Sound Basin and Their Responses to Dissolved Oxygen Deficiency. *Can. Tech. Rep. Fish. Aquat. Sci.*, No. 951, 1980.

Levings, C. D. Biological Reconnaissance of an Abandoned Mine Tailings Disposal Area in Toquart Bay, Barkley Sound, B. C. *Fish. Res. Board Canada Mss. Rep. Ser.* 1362, 1975, 9 pp.

Levings, C. D., and N. McDaniel. Biological Observations from the Submersible Pisces IV Near Britannia Beach, Howe Sound, B. C. *Fish. Res. Board of Can., Tech. Rep.*, No. 409, 1973, 23 pp.

Levings, C. D., R. E. Foreman, and V. J. Tunnicliffe. Review of the Benthos of the Strait of Georgia and Contiguous Fjords. *Can. J. Fish. Aquat. Sci.*, v. 40, 1983, pp. 1120-1141.

Lewis, A. G., and W. R. Cave. The Biological Importance of Copper in Oceans and Estuaries. *Oceanogr. Mar. Biol. Annu. Rev.*, v. 20, 1982, pp. 471-695.

Lewis, A. G., P. H. Whitfield, and A. Ramnarine. Some Particulate and Soluble Agents Affecting the Relationship Between Metal Toxicity and Organism Survival in the Calanoid Copepod *Euchaeta Japonica*. *Mar. Biol.*, v. 17, 1972, pp. 215-221.

Lie, U., and J. C. Kelly. Benthic Infauna Communities off the Coast of Washington and in Puget Sound: Identification and Distribution of the Communities. *J. of the Fish. Res. Board of Can.*, v. 27, 1970, pp. 621-651.

Limpsaichol P., and T. Poopetch. The Effect of Dumping Suspended Solids at Sea on Chlorophyll A Concentrations and Primary Production Values. *Phuket Mar. Biol. Cent., Res. Bull.* 33, Phuket, Thailand, 1984.

Limpsaichol, P. A Survey of Offshore Dredging Discharged Particle Pattern and its Relation to Chlorophyll A of Phytoplankton. *Paper Pres. at the 8th Conf. of Sci. and Technol.*, 28-30 Oct., Chulalongkorn Univ., 1982.

Lipovsky, V. P., and K. K. Chew. Mortality of Pacific Oysters (*Crassostrea Gigas*): The Influence of Temperature and Enriched Seawater on Oyster Survival. *Proc. Nat. Shellfish. Assoc.*, v. 62, 1972, pp. 73-82.

- Littlepage, J. L. Oceanographic and Marine Biological Surveys, Alice Arm and Hastings Arm, B. C. 1974-1977. Rep. to Climax Molybdenum Corp. of B. C. Ltd., 1978.
- Luoma, S. N. Biological Availability of Sediment-bound Trace metals. La Baie de Seine (Greco-Manche), Universite de Caen, 24-26 Avril. IFREMER. Actes de Colloques, 1986, No. 4, 1985, pp. 347-362.
- Luoma, S. N., and G. W. Bryan. Factors Controlling the Availability of Sediment-bound Lead to the Estuarine Bivalve, *Scrobicularia plana*. J. Mar. Biol. Assoc. U. K., v. 58, 1978, pp. 793-902.
- Lussier, S. M., J. H. Gentile, and J. Walker. Acute and Chronic Effects of Heavy Metals and Cyanide on *Mysidopsis Bahia* (Crustacea: Mysidacea). Aquat. Toxicol., v. 7, 1985, pp. 25-35.
- Macek, K. J., S. R. Petrocelli, and B. H. Sleight III. Considerations in Assessing the Potential for, and Significance of Biomagnification of Chemical Residues in Aquatic Food Chains. Ch. in Aquat. Toxicol., ed. by L. L. Marking and R. A. Kimerle. ASTM STP 667, ASTM, 1979, pp. 251-268.
- Mackas, D. L., and E. P. Anderson. Effects of Suspended Mine Tailings on Zooplankton Physiology and Distribution in the Alice Arm Fjord System. Sum. Prog. Rep. to the McInerney Panel, 1983.
- MacPhee, C., and R. Ruelle. Lethal Effects of 1888 Chemicals Upon Four Species of Fish From Western North America. Forest, Wildlife and Range Experiment Station, Univ. of ID. Bull., No. 3, 1969.
- Maestrini, S. Y., D. J. Bonin, and M. R. Droop. Phytoplankton as Indicators of Sea Water Quality: Bioassay Approaches and Protocols. Ch. in Algae as Ecol. Indicators, ed. by E. Shubert, Acad., 1984.
- Maestrini, S. Y., M. R. Droop, and D. J. Bonin. Test Algae as Indicators of Sea Water Quality: Prospects. Ch. in Algae as Ecol. Indicators, ed. by E. Shubert, Acad., 1984.
- Malins, D. C., B. B. McCain, D. W. Brown, A. K. Sparks, and H. O. Hodgins. Chemical Contaminants and Biological Abnormalities in Central and Southern Puget Sound. Boulder, CO.: U. S. Nat. Oceanic and Atmos. Admin. Mar. Pollut. Assess. (NOAA Tech. Mem. OMPA-2), 1980.
- Manley, A. R. The Effects of Copper on the Behavior, Respiration, Filtration and Ventilation Activity of *Mytilus edulis*. J. Mar. Assoc. UK, v. 63, No. 1, 1983, pp. 205-222.
- Manley, A. R., and J. Davenport. Behavioural Responses of Some Marine Bivalves to Heightened Seawater Copper Concentrations. Bull. Environ. Contam. Toxicol., v. 22, 1979, pp. 739-744.
- Manley, A. R., L. D. Gruffydd, and P. C. Almada-Villela. The Effect of Copper and Zinc on the Shell Growth of *Mytilus edulis* Measured by a Laser Diffraction Technique. J. Mar. Biol. Assoc. UK, v. 64, 1984, pp. 417-427.
- Mathews, J. B. L., and B. R. Heimdal. Pelagic Productivity and Food Chains in Fjord Systems. Ch. in Fjord Oceanogr., ed. by H. J. Freeland, D. M. Farmer, and C. D. Levings, Plenum, 1980, pp. 377-398.
- Mattson, C. R., and B. L. Wing. Ichthyoplankton Composition and Plankton Volumes from Inland Coastal Waters of Southeastern Alaska, Apr.-Nov. 1972. NOAA Tech. Rep. NMFS-723, 1978.
- Maurer, D. L., R. T. Keck, J. C. Tinsman, W. A. Leathem, and C. A. Wethe. Vertical Migration of Benthos in Simulated Dredged Material Overburdens, Marine Benthos. Delaware Univ. Lewes Coll. of Mar. Studies, D-78-35, U.S. Army Eng. Waterway Experiment Station, Vicksburg, MS., v. 1, 1978.
- Maynard, D. J., and D. D. Weber. Avoidance Reactions of Juvenile Coho Salmon (*Oncorhynchus kisutch*) to Monocyclic Aromatics. Can. J. Fish. Aquat. Sci., v. 38, No. 7, 1981, pp. 772-778.
- McCall, P. L. Community Patterns and Adaptive Strategies of the Infaunal Benthos of Long Island Sound. J. Mar. Res., v. 35, No. 2, 1977, pp. 221-266.
- McDaniel, N. G. Survey of the Benthic Macroinvertebrate Fauna and Solid Pollutants in Howe Sound. Fish. Res. Bd. Can., Tech. Rep., No. 385, 1973.

McDaniel, N. G., C. D. Leveing, D. Goyette, and D. Brothers. Otter Trawl Catches at Disrupted and Intact Habitats in Howe Sound, Jervis Inlet, and Bute Inlet, B. C., August, 1976 to December, 1977. Fish. & Mar. Service Data Rep., No. 92, 1978.

McFarland, V. A., and R. K. Peddicord. Lethality of a Suspended Clay to a Diverse Selection of Marine and Estuarine Macrofauna. Arch. Environ. Contam. Toxicol., v. 9, 1980, pp. 733-741.

McGreer, E. R. Sublethal Effects of Heavy Metal Contaminated Sediments on the Bivalve, *Macoma balthica* (L). Mar. Pollut. Bull., v. 10, 1979, pp. 259-262.

McGreer, E. R., B. J. Reid, and G. A. Vigers. Availability of Metals from Inorganic Particulates (Mine Tailings) for Uptake by Marine Invertebrates. EVS Consultants Ltd., Project 646, for Dr. M. Waldichuk, Dep. of Fish. & Oceans, Vancouver, B. C., 1980.

McLeay and Associates Ltd. Bioaccumulation Studies With Bivalves Exposed to Alice Arm Sediment Contaminated with Amax/Kitsault Mine Tailings. Prepared for Water Quality Unit, Habitat Management Div., Fish. and Oceans Canada, 1984.

McMurray, G., P. Fishman, R. Cimberg, and T. Keegan. Trophic Structure Variability in Two Adjacent Southeastern Alaska Fjords. Abstr. Submitted to 15th Pac. Sci. Congr., Dunedin, New Zealand,.

Mearns, A. J., and D. R. Young. The Manner in Which Organisms Concentrate Pollutants. Proc. Oceans 783 - Technol. Papers. Aug. 29 - Sep. 1. San Francisco, CA. Mar. Technol. Soc., v. 2, 1983, pp. 927-931.

Mearns, A. J., and M. J. Sherwood. Distribution of Neoplasms and Other Diseases in Marine Fishes Relative to the Discharge of Waste Water. Anal. of the NY Acad. of Sci., v. 298, 1977, pp. 210-224.

Meehan, W. R. Effects of Gravel Cleaning on Bottom Organisms in Three Southeast Alaska Streams. Prog. Fish. Cult., v. 33, 1971, pp. 107-111.

Messieh, S. N., D. J. Wildish, and R. H. Peterson. Possible Impact From Dredging and Spoil Disposal on Miramichi Bay Herring Fishery. Fish. Res. Board of Canada. Tech. Rep. of Fish. and Aquat. Sci., No. 1008, 1981.

Mitchell, D. G., J. D. Morgan, G. A. Vigers, and P. M. Chapman. Acute Toxicity of Mine Tailings to Four Marine Species. Mar. Pollut. Bull., v. 16, No. 11, 1985, pp. 450-455.

Mitchell, D. G., J. D. Morgan, G. A. Vigers, and P. M. Chapman. Acute Lethal Marine Bioassay Studies for the U. S. Borax Quartz Hill Project. 11th Annu. Aquat. Toxicity Workshop, Vancouver, B.C. Nov. 13-15, 1984.

Mitrovic, V. V. Sublethal Effects of Pollutants on Fish. Ch. in Mar. Pollut. and Sea Life, ed. by M. Ruivo, FAO UNIPUB, 1973, pp. 252.

Moore, M. N., J. Widdows, J. J. Cleary, R. K. Pipe, et al. Responses of the Mussel *Mytilus edulis* to Copper and Phenanthrene: Interactive Effects. Mar. Environ. Res., v. 14, 1984, pp. 167-183.

Moore, P. G. Inorganic Particulate Suspensions in the Sea and Their Effects on Marine Animals. Oceanogr. Mar. Biol. Annu. Rev., v. 15, 1977, pp. 225-363.

Morel, F. M. M., and N. M. L. Morel-Laurens. Trace Metals and Plankton in the Oceans: Facts and Speculations. Trace Metals in Seawater (Proc. of a NATO Conf., Advanced Res. Inst. on Trace Metals in Seawater, Held Mar. 30 - Apr. 3, in Erice, Sicily, Italy). Plenum, 1983, 1981, pp. 841-869.

Morton, B. A Note on the Cytological Structure and Function of the Digestive Diverticula of *Macoma balthica* Correlated With the Rhythm of the Tide. Malacological Rev., v. 3, 1970, pp. 115-119.

Nasu, Y., and M. Kugimoto. Lemna (duckweed) as an Indicator of Water Pollution. I. The Sensitivity of Lemna Paucicosta to Heavy Metals. Bull. Environ. Contam. Toxicol., v. 10, 1981, pp. 159-169.

- Nateewathana A., and P. Tantichodok. Species Composition, Density and Biomass of Macrofauna at Ko Yao Yai, Southern Thailand. Proc. Asian Symp. Mangrove Environ.-Res. and Management, 1984, pp. 258-285.
- National Academy of Science. The International Mussel Watch. 1980, 248 pp.
- Neff, J. W., R. S. Foster, and J. F. Slowey. Availability of Sediment-Absorbed Heavy Metals to Benthos with Particular Emphasis on Deposit Feeding Infauna. Tech. Rep. D-78-42, U. S. Army Eng. Waterways Experiment Station, Vicksburg, MS., 1978.
- New Scientist. Polluted Prawns on Paradise Island. No. 1691, 1989, p. 19.
- Noggle, C. The Behavior and Physiological Effects of Suspended Sediment on Juvenile Salmonids. Ch. in Fish. and Mar. Serv. Tech. Rep. No. 818, ed. by J. C. Davis, G. L. Greer, and I. K. Birtwell, Fish. and Oceans Can., 1978, pp. 54-63.
- Noggle, C. C. Behavior, Physiological and Lethal Effects of Suspended Sediment of Juvenile Salmonids. M. S. Thesis. Univ. of WA., 1978.
- O'Connell, G. W. Oceanographic and Marine Biological Surveys in Alice Arm and Hastings Arm, B. C., Features of the Intertidal and Subtidal Macrobiota of Alice Arm and Hastings Arm. Dobrocky Seatech Ltd. for Dr. J. L. Littlepage, Oceanogr. Consultant Program Direct., Alice Arm Surv., No. 2.
- O'Connell, G. W., and S. Byers. Oceanographic and Marine Biological Surveys in Alice Arm and Hastings Arm, British Columbia, Features of the Intertidal and Subtidal Macrobiota of Alice Arm and Hastings Arm, B. C. Dobrocky Seatech Ltd. for Dr. J. L. Littlepage, Program Direct., Alice Arm Surv., 1977.
- Paffenhofer, G. A. The Effects of Suspended 'Red Mud' on Mortality, Body Weight, and Growth of the Marine Planktonic Copepod, *Cananus Helgolandicus*. Water, Air, and Soil Pollut., v. 1, 1972, pp. 314-321.
- Page, D. S., B. T. Page, J. R. Hotham, E. S. Gilfillan, and R. P. Gerber. Bioavailability of Toxic Constituents of Used Drilling Muds. Symp., Res. on Environ. Fate and Effects of Drilling Fluids and Cuttings, Lake Buena Vista, FL, Jan. 21-24, 1980.
- Palaniappan, V. M. Ecology of Tin Tailings Areas: Plant Communities and Their Succession. J. Appl. Ecol., v. 11, 1974, pp. 133-150.
- Palmer, R. E. A Histological and Histochemical Study of Digestion in the Bivalve *Arctica Islandica* L. Biol. Bull. Mar. Biol. Lab., Woods Hole, MA, v. 156, 1979, pp. 115-129.
- Parsons, T. R., P. Thompson, W. Yong, D. M. Lalli, H. Shumin, and X. Huaishu. The Effect of Mine Tailings on the Production of Plankton. Acta. Oceanol. Sinica, v. 5, No. 3, 1986, pp. 417-423.
- Pauley, G. B., and A. K. Sparks. Preliminary Observations on the Acute Inflammatory Reaction in the Pacific Oyster, *Crassostrea Gigas* (Thunberg). J. Of Invert. Pathol., v. 7, 1965, pp. 248-256.
- Pearson, T. H., and R. Rosenberg. Macrobenthic Succession in Relation to Organic Enrichment and Pollution of the Marine Environment. Oceanogr. Mar. Biol. A. Rev., v. 16, 1978, pp. 229-311.
- Pearson, T. H., J. S. Gray, and P. J. Johannessen. Objective Selection of Sensitive Species Indicative of Pollution Induced Change in Benthic Communities. 2. Data Analysis. Mar. Ecol. Prog. Ser., v. 12, 1983, pp. 237-255.
- Peddicord, R. K. Direct Effects of Suspended Sediments on Aquatic Organisms. Ch. in Contam. and Sediments, Fate and Transport, Case Studies, Modeling, Toxicity, ed. by R. A. Baker, Ann Arbor Sci., v. 1, 1980, pp. 501-536.
- Peddicord, R. K., and V. A. McFarland. Effects of Suspended Dredged Material on Aquatic Animals. CA Univ. Bodega Bay, Bodega Mar. Lab., D-78-29, U. S. Army Waterway Experiment Station, Vicksburg, MS., 1978.

- Peddicord, R. K., V. A. McFarland, D. P. Bilfiori, and T. E. Byrd. Effects of Suspended Solids on San Francisco Bay Organisms. Appendix G. Phys. Impacts of Dredge Disposal Study, San Francisco Bay and Estuary. U. S. Army Corps of Eng., San Francisco District, 1975.
- Phelps, D. K., G. Telek, and R. L. Lapan, Jr. Assessment of Heavy Metal Distribution Within the Food Web. Ch. in Mar. Pollut. and Mar. Waste Disposal, ed. by E. Pearson, and E. D. Frangipane, Pergamon, 1975, pp. 341-348.
- Phillips, D. J. H. The Use of Biological Indicator Organisms to Monitor Trace Metal Pollution in Marine and Estuarine Environments - A Review. Environ. Pollut., v. 13, No. 4, 1977, pp. 281-317.
- Phillips, D. J. H. Quantitative Aquatic Biological Indicators. London: Appl. Sci., 1980, 488 pp.
- Phillips, D. J. H. The Common Mussel, *Mytilus Edulis* as an Indicator of Pollution by Zinc, Cadmium, Lead and Copper. I. Effects of Environmental Variables on Uptake of Metals. Mar. Biol. (Berl.), v. 38, 1976, pp. 59-69.
- Phillips, D. J. H., et al. Trace Metals, The Concept of Indicator Species. The Int. Mussel Watch, Nat. Acad. of Sci., Washington, D. C., 1980.
- Phillips, D. J. H., T. Balkas, et al. Trace Metals, The International Mussel Watch, Report of a Workshop Sponsored by the Environmental Studies Board, Commission on Nat. Resour., and Natl. Res. Council. Natl. Acad. of Sci., Washington, D. C., 1980.
- Phillips, G. R., and R. C. Russo. Metal Bioaccumulation in Fishes and Aquatic Invertebrates: A Literature Review. EPA-600/3-78-103, 1978.
- Plaskett, D., and J. C. Potter. Heavy Metal Concentrations in the Muscle Tissue of 12 Species of Teleost From Cockburn Sound, Western Australia. Aust. J. Mar. Freshwater Res., v. 30, 1979, pp. 607-616.
- Plumb, R. H., Jr., and G. F. Lee. Response of Lake Superior Algae to Nutrients and Taconite Tailings. J. Water Pollut. Control Fed., v. 47, No. 3, 1975, pp. 619-625.
- Popham, J. D., and J. M. D'Auria. Statistical Models for Estimating Seawater Metal Concentrations from Metal Concentrations in Mussels, *Mytilus edulis*. Bull. Environ. Contam. Toxicol., v. 27, 1981, pp. 660-670.
- Popham, J. D., and J. M. D'Auria. A New Sentinel Organism for Vanadium and Titanium. Mar. Pollut. Bull., v. 13, 1982, pp. 25-27.
- Popham, J. D., and J. M. D'Auria. Statistical Approach for Deciding if Mussels (*Mytilus edulis*) Have Been Collected from a Water Body Polluted with Trace Metals. Environ. Sci. Technol., v. 17, 1983, pp. 576-582.
- Popham, J. D., and J. M. D'Auria. Combined Effect of Body Size, Season, and Location on Trace Element Levels in Mussels (*Mytilus edulis*). Arch. Environ. Contam. Toxicol., v. 12, 1983, pp. 1-14.
- Popham, J. D., D. C. Johnson, and J. M. D'Auria. Mussels *Mytilus edulis* as 'Point Source' Indicators of Trace Metal Pollution. Mar. Pollut. Bull., v. 11, 1980, pp. 261-263.
- Portmann, J. E. Results of Acute Toxicity Tests with Marine Organisms, Using a Standard Method. Ch. in Mar. Pollut. and Sea Life, ed. by M. Ruivo, Fishing News (Books) Ltd., Surrey, England, 1972.
- Powell J. H. The Toxicity of Six Mining Process Flotation Reagents to the Marine Mullet (*Valamugil Buchanni*). Potassium Amyl Xanthate (PAX). BCM Rep. RB 100, 1979.
- Powell, J. H. Aquatic Biology Research Conducted by Bougainville Copper Ltd. 1979.
- Powell, J. H. A Statistical Comparison of Trace Elements in Fish From the East and West Coasts of Bougainville Island. BCM Rep. RC 036, 1981.
- Powell, J. H. A Review of the Toxicity of Copper to Aquatic Organisms. BCM Rep. RC 056, 1981.

- Powell, J. H. The Effect of Marine Tailings Disposal on Fish Communities on Bougainville Island. BCM Rep. RC 063, 1982.
- Powell, J. H. The Effect of Marine Tailings Disposal on Shallow Benthic Communities at Bougainville Island. BCM Rep. RC 093, 1983, 100 pp.
- Powell, J. H., R. E. Powell, and D. R. Fielder. Trace Element Concentrations in Tropical Marine Fish at Bougainville Island, Papua New Guinea. *Water, Air and Soil Pollut.*, v. 15, 1981, pp. 323-327.
- Probert, P. K. The Bottom Fauna of China Clay Waste Deposits in Mebagissey Bay. *J. Mar. Biol. Assoc. U. K.*, v. 55, No. 1, 1975, pp. 19-44.
- Ratowsky, D. A., S. J. Thrower, I. J. Eustace, and J. Olley. A Numerical Study of the Concentration of Some Heavy Metals in Tasmanian Oysters. *J. Fish. Res. Bd. Can.*, v. 31, 1974, pp. 1165-1167.
- Ray, S. D., W. McLeese, and M. R. Peterson. Accumulation of Copper, Zinc, Cadmium and Lead From Two Contaminated Sediments by Three Marine Invertebrates - A Laboratory Study. *Bull. Environ. Contam. Toxicol.*, v. 26, 1981, pp. 315-322.
- Ray, S., and D. W. McLeese. Factors Affecting Uptake of Cadmium and Other Trace Metals from Marine Sediments by Some Bottom Dwelling Marine Invertebrates. Ch. in *Waste in the Ocean, Dredge Mater. Disposal in the Ocean*, ed. by D. R. Kester, B. H. Ketchum, I. W. Duedall, and P. K. Park, Wiley, 1983, pp. 186-197.
- Razzell, W. E., and P. C. Trussell. Microbiological Leaching of Metallic Sulfides. *Appl. Microbiol.*, v. 11, 1962, pp. 105-110.
- Reid, B. J. Preliminary Laboratory Study of the Effects of Burial by Amax/Kitsault Mine Tailings on Marine Invertebrates(Microform). Water Quality Unit, Habitat Management Div., Field Serv. Branch, Dep. of Fish. and Oceans, 1984, 44 pp.
- Reish, D. J. The Use of Marine Invertebrates as Indicators of Varying Degrees of Marine Pollution. Ch. in *Mar. Pollut. and Sea Life*, ed. by M. Ruivo, Food and Agri. Org. of the United Nations (FAO), 1973, pp. 203-207.
- Reish, D. J. Bristle Worms Annelida Polychaeta. Ch. in *Pollution Ecology of Estuarine Invertebrates*, ed. by C. W. Hart, Jr., and S. L. M. Fuller, Academic, 1979.
- Reish, D. J., F. Piltz, and J. M. Martin. Introduction of Abnormal Polychaete Larvae by Heavy Metals. *Mar. Pollut. Bull.*, v. 5, 1974, pp. 125-126.
- Rescan Environmental Services, Ltd. Island Copper Mine Crab Report. 1986.
- Rhoads, D. C., and D. K. Young. The Influence of Deposit Feeding Organisms on Sediment Stability and Community Trophic Structure. *J. Mar. Res.*, v. 28, 1970, pp. 150-178.
- Richardson, M. D., A. G. Carey, Jr., and W. A. Colgate. Aquatic Disposal Field Investigations, Columbia River Disposal Site, Oregon, Appendix C. The Effects of Dredged Material Disposal on Benthic Assemblages. Tech. Rep. D-77-30, School of Oceanogr., OR. State Univ., 1977.
- Ritz, D. A., R. Swain, and N. G. Elliott. Use of the Mussel, *Mytilus Edulis Planulatus*, (Lamarck) in Monitoring Heavy Metal Levels in Seawater. *Aust. J. Mar. Freshwater Res.*, v. 33, No. 3, 1982, pp. 491-506.
- Roberts, K. J. Interdependency Specification: An Aid to Local Estuary Management. Preprint 8th Annu. Conf. and Expos. Mar. Tech. Soc., Applica. of Mar. Tech. to Human Needs, 1972, pp. 129-147.
- Rogers, B. A. Tolerance Levels of Four Species of Estuarine Fishes to Suspended Mineral Solids. M. S. Thesis, Univ. of RI., 1969.
- Rose, C. D. Mortality of Market-sized Oysters (*Crassostrea virginica*) in the Vicinity of a Dredging Operation. *Chesapeake Sci.*, v. 14, No. 2, 1973, pp. 135-138.

- Rosenberg, R. Effects of Dredging Operations on Estuarine Benthic Macrofauna. *Mar. Pollut. Bull.*, v. 8, 1977, pp. 102-104.
- Rubinstein, N. I., and R. Rigby. Acute and Sublethal Effects of Whole Used Drilling Fluids on Representative Estuarine Organisms. *Symp., Res. on Environ. Fate and Effects of Drilling Fluids and Cuttings, Lake Buena Vista, FL*, Jan. 21-24, 1980.
- Rygg, B. Effect of Sediment Copper on Benthic Fauna. *Mar. Ecol. Prog. Ser.*, v. 25, 1985, pp. 83-89.
- Rygg, B. Distribution of Species Along Pollution-Induced Diversity Gradients. *Mar. Pollut. Bull.*, v. 16, 1985, pp. 469-474.
- Rygg, B. Heavy-Metal Pollution and Log-Normal Distribution of Individuals Among Species in Benthic Communities. *Mar. Poll. Bull.*, v. 17, 1986, pp. 31-36.
- Rygg, B., and J. Skei. Correlation Between Pollutant Load and the Diversity of Marine Soft-Bottom Fauna Communities. Ch. in *Proc. Int. Workshop Biol. Testing of Effluents (and Related Receiving Waters), OECD/US EPA/Environ. Can.*, 1984, pp. 153-183.
- Sanders, J. G. Enrichment of Estuarine Phytoplankton by the Addition of Dissolved Manganese. *Mar. Environ. Res.*, v. 1, No. 1, 1978, pp. 59-66.
- Saunda, W. G., and R. L. Ferfuson. Sensitivity of Natural Bacterial Communities to Additions of Copper and to Cupric Ion Activity: A Bioassay of Copper Complexation in Seawater. Ch. in *Trace Metals in Seawater*, ed. by C. S. Wong, et al, NATO Sci. Affairs Div., Plenum, 1983, pp. 871-891.
- Schulz-Baldes, M. Lead Uptake From Sea Water and Food, and Lead Loss in Common Mussel, *Mytilus Edulis*. *Mar. Biol.*, v. 25, No. 3, 1974, pp. 177-193.
- Servizi, J. A., R. W. Gordon, and D. W. Martens. Marine Disposal of Sediments From Bellingham Harbor as Related to Sockeye and Pink Salmon Fisheries. *Prog. Rep. No. 23, Int. Pac. Sal. Fish. Comm.*, 1969.
- Shaw, K. M., P. J. D. Lamshead, and H. M. Platt. Detection of Pollution-Induced Disturbance in Marine Benthic Assemblages With Special Reference to Nematodes. *Mar. Ecol. Prog. Ser.*, v. 11, 1983, pp. 195-202.
- Sheffrin, N. M. H., and E. E. Williams. Behavioural Bioassay for Impaired Sea-Water Quality using the Plantigrades of the Common Mussel *Mytilus edulis*: The Effect of pH on Copper Speciation and Toxicity. *Aquat. Toxicol.*, v. 5, 1984, pp. 109-116.
- Sheffrin, N. M. H., N. R. J. Fieller, and E. E. Williams. A Behavioral Bioassay for Impaired Sea-Water Quality Using the Plantigrades of the Common Mussel, *Mytilus Edulis* L. : The Response to Copper. *Aquat. Toxicol.*, v. 5, 1984, pp. 77-91.
- Sherk, J. A. Jr., J. M. O'Connor, and D. A. Neumann. Effects of Suspended Solids on Selected Estuarine Plankton. U. S. Army, Corps of Eng., Res. Cent., Kingman Building. Fort Belvoir, VA., 1976.
- Sherk, J. A., and L. E. Cronin. The Effects of Suspended and Deposited Sediments on Estuarine Organisms: An Annotated Bibliography of Selected References. *Natur. Resour. Inst., Univ. of Maryland, NRI Ref.-70-19*, 1970.
- Shick, J. M. Physiological and Behavioral Responses to Hypoxia and Hydrogen Sulfide in the Infaunal Asteroid *Ctenodiscus Crespatus*. *Mar. Biol.*, v. 37, 1976.
- Sibuet, M. (ed.). Abstracts of Fifth Deep-Sea Biology Symposium. Brest, France, Jun. 26 - Jul. 1, 1988.
- Silverman, M. P. Mechanism of Bacterial Pyrite Oxidation. *J. of Bacteriol.*, v. 94, No. 4, 1967, pp. 1046-1051.
- Smetacek, V. Annual Cycle of Sedimentation in Relation to Plankton Ecology, Western Kiel Bight. *Ophelia Suppl.*, v. 1, No. 65, 1980.

- Smith, D. W. Tolerance of Juvenile Chum Salmon (*Oncorhynchus Keta*) to Suspended Sediments. M. S. Thesis, Univ. of WA., 1978.
- Smith, D. W. Tolerance of Juvenile Chum Salmon (*Oncorhynchus keta*) to Suspended Sediments (Static Bioassay). Ch. in Trident Dredging Study: The Effects of Dredging at the U. S. Naval Submarine Base at Bangor on Outmigrating Juvenile Chum Salmon, *Oncorhynchus Keta* in Hood Canal, WA., ed. by E.O. Salo, et al, FRI-UW, 1979, pp. 20-62.
- Smith, J. L., R. Albright, and A. D. Rammer. The Effects of Intertidal Dredged Material Disposal on Benthic Invertebrates in Grays Harbor, Washington. Appendix E - Invertebrates. WA Dep. of Game. U. S. Army Corps of Eng. Seattle, WA., 1976.
- Smith, R. W., and C. S. Greene. Biological Communities Near Submarine Outfall. J. Water Pollut. Cont. Fed., v. 48, 1976, pp. 1894-1912.
- Sousa, W. P. Experimental Investigations of Disturbance and Ecological Succession in a Rocky Intertidal Algal Community. Ecol. Mono., v. 49, No. 3, 1979, pp. 227-254.
- Sprague, J. B. A Review of Toxicity and Tissue Residues of Lead, Zinc, and Cadmium for Marine Molluscs and Crustaceans. 11th Annu. Aquat. Toxicity Workshop, Vancouver, B.C., Nov. 13-15, 1984.
- Stenner, R. D., and G. Nickless. Distribution of Some Heavy Metals in Organisms in Hardangerfjord and Skjerstadfjord, Norway. Water, Air, and Soil Pollut., v. 3, 1974, pp. 279-291.
- Stephens, K., and J. Sibert. Primary Production in Rupert Inlet, B. C. 5th Tech. Conf. Estuaries of the Pac. Northwest. Oregon State Univ. Corvallis, OR., 1976.
- Stockner, J. G., D. D. Cliff, and D. B. Buchanan. Phytoplankton Production and Distribution in Howe Sound British-Columbia, Canada, A Coastal Marine Embayment Fjord Under Stress. J. Fish. Res. Bd., Can., v. 34, No. 7, 1977, pp. 907-917.
- Strong, C. R., and S. N. Luoma. Variations in the Correlation of Body Size with Concentrations of Cu and Ag in the Bivalve, *Macoma Balthica*. Can. J. Fish. Aquat. Sci., v. 38, 1981, pp. 1059-1064.
- Stump, I. G., J. Kearney, J. M. D'Auria, and J. D. Popham. Monitoring Trace Elements in the Mussel, *Mytilus Edulis*, Using X-ray Energy Spectroscopy. Mar. Pollut. Bull., v. 10, No. 9, 1979, pp. 270-274.
- Sullivan, D. L. The Effects of Marine Disposal of Mine Tailings on Phytoplankton Productivity in Rupert Inlet, B. C. 1974-1976. Environ. Protect. Serv. Prog. Rep.: 79-16, 1979.
- Sunda, W. G. and J. M. Lewis. Effect of Complexation by Natural Organic Ligands on the Toxicity of Copper to a Unicellular Alga, *Monochrysis Lutheris*. Limnol. Oceanogr., v. 23, No. 5, 1978, pp. 870-876.
- Sunila, I. Histopathology of Mussels (*Mytilus edulis* L.) from the Tvarminne Area the Gulf of Finland (Baltic Sea). Annu. Zoologici Fennici, v. 24, 1987, pp. 55-69.
- Sunila, I. Histopathological Changes in the Mussel *Mytilus Edulis* L. at the Outlet From a Titanium Dioxide Plant in Northern Baltic. Annu. Zoologici Fennici, v. 23, 1986, pp. 61-70.
- Swartz, R. C., W. A. DeBen, and F. A. Cole. A Bioassay for the Toxicity of Sediment to Marine Macrobenthos. J. Water Pollut. Control Fed., v. 51, No. 5, 1979, pp. 944-950.
- Swartz, R. C., W. A. DeBen, J. K. P. Jones, J. O. Lamberson, and F. A. Cole. Phoxocephaled Amphipod Bioassay for Marine Sediment Toxicity. Ch. in Aquat. Toxicol. and Hazard Assess.: Seventh Symp., ASTM STP 854, ed. by R. D. Cardwell, R. Purdy, and R. C. Bahner, Am. Soc. for Testing and Mater., Philadelphia, 1985, pp. 284-307.
- Swartz, R. C., W. A. Deben, K. A. Sercu, and J. O. Lamberson. Sediment Toxicity and the Distribution of Amphipods in Commencement Bay, Washington, USA. Mar. Pollut. Bull., v. 13, 1982, pp. 359-364.

- Taylor, D., B. G. Maddock, and G. Mance. The Acute Toxicity of Nine "Grey List" Metals (Arsenic, Boron, Chromium, Copper, Lead, Nickel, Tin, Vanadium and Zinc) to Two Marine Fish Species: Dab (*Limanda*) and Grey Mullet (*Chelon Labrosus*). *Aquat. Toxicol.*, v. 7, 1985, pp. 135-144.
- Taylor, L. Marine Reclamation: Recovery of the Sea Floor Community Following Mine Tailing Discharge. Proc. 8th Annu. B. C. Mine Reclamation Symp. Victoria, B. C., 1984.
- Taylor, L. A. Marine Macrobenthic Colonization of Mine Tailings in Rupert Inlet. B. C. MSc Thesis, Univ. Victoria, 1986, 155 pp.
- Thiel, H., and H. Weikert. Biological Oceanography of the Red Sea Oceanic System. *Deep-Sea Res.*, v. 31, No. 6/8A, 1984, pp. 829-831.
- Thiel, H., O. Peannkuche, R. Theeg, and G. Schriever. Benthic Metabolism and Standing Stock in the Central and Northern Deep Red Sea. *Mar. Ecol.*, v. 8, No. 1, 1987, pp. 1-20.
- Thomas, W. H., and D. L. R. Seibert. Effects of Copper on the Dominance and the Diversity of Algae: Controlled Ecosystem Pollution Experiment. *Bull. Mar. Sci.*, v. 27, 1977, pp. 23-33.
- Thompson, K. A., D. A. Brown, P. M. Chapman, and R. O. Brinkhurst. Histopathological Effects and Cadmium-Binding Protein Synthesis in the Marine Oligochaete *Monopylephorus Cuticulatus* Following Cadmium Exposure. *Tran. Am. Microsc. Soc.*, v. 101, No. 1, 1982, pp. 10-26.
- Thurberg, F. P., M. A. Dawson, and R. S. Collier. Effects of Copper and Cadmium on Osmoregulation and Oxygen Consumption in Two Species of Estuarine Crabs. *Mar. Biol.*, v. 23, No. 3, 1973, pp. 171-175.
- Topping, G. The Analysis of Trace Metals in Biological Reference Materials: A Discussion of the Results of the Intercomparison Studies Conducted by the International Council for the Exploration of the Sea. Ch. in *Trace Metals in Seawater*, ed. by C. S. Wong, et al, NATO Sci. Affairs Div., Plenum, 1983, pp. 155-173.
- Tuovinen, O. H., S. I. Niemela, and H. G. Gyllenberg. Tolerance of *Thiobacillus Ferrooxidans* to Some Metals. *Antonie Van Leeuwenhoek J. of Microbiol., Sereol.*, v. 37, 1971, pp. 489-496.
- Turk, T. R., and M. J. Risk. Effect of Sedimentation on Infaunal Invertebrate Populations of Cobequid Bay, Bay of Fundy. *Can. J. of Fish. and Aquat. Sci.*, v. 38, 1981, pp. 642-648.
- University of Rhode Island, Marine Experiment Station. (ed.). *Biological Effects of Ocean Disposal of Solid Waste*. Graduate School of Oceanogr., RI., 1973, 53 pp.
- Vanderhorst, J. R. Experimental Studies of Early Infaunal Recovery as a Measure of Marine Sediment Contamination. *Coastal Ocean Pollut. Assess. News, Man and the Mar. Environ.*, v. 3, No. 2, 1984, pp. 19.
- VTN Consolidated, Inc. (ed.). *Benthic Smothering and Recolonization Studies in Boca de Quadra*. Rep. U. Borax, 55 Appendices, 1983, 55 pp.
- VTN Consolidated, Inc. *Data Summary, Salmon Outmigrant Study*. 1981, 8 pp.
- VTN Consolidated, Inc. 1981 *Wilson Arm/Smeaton Bay Baseline Report*, Coastal and Marine Biology Program, Quartz Hill Molybdenum Project. 1981.
- VTN Consolidated, Inc. 1982 *Distribution, Abundance and Food Habits of Juvenile Salmon at the Heads of Wilson Arm/Smeaton Bay and Boca de Quadra*. 1982.
- VTN Consolidated, Inc. 1982 *Herring Studies, Boca de Quadra and Wilson Arm/Smeaton Bay, Annual Environmental Report*. 1982.
- VTN Consolidated, Inc. 1982 *Nursery Studies - Finfish, Boca de Quadra and Wilson Arm/Smeaton Bay*. 1982.
- VTN Consolidated, Inc. 1982 *Nursery Studies - Shellfish, Boca de Quadra and Wilson Arm/Smeaton Bay*. 1982.

- Wagemann, R. Comparison of Heavy Metals in Two Groups of Ringed Seals (*Phoca hispida*) From the Canadian Arctic. *Can. J. Fish. Aquat. Sci.*, v. 46, 1989, pp. 1558-1563.
- Waldichuk, M. Mine Waste Disposal into the Sea and Impact of Metals on Biota: A Comparison of Two Situations. *Int. Workshop Trans. Pollut. in Two Southern Hemisphere Ocean Systems, Plettenberg Bay, Republic of South Africa*, Apr. 23-25, 1979, 28 pp.
- Waldichuk, M. Biological Availability of Metals to Marine Organisms. *Mar. Pollut. Bull.*, v. 16, No. 1, 1985, pp. 7-11.
- Waldichuk, M. Effects of Pollutants on Marine Organisms: Improving Methodology of Evaluation - A Review of the Literature. *J. Water Pollut. Control Fed.*, v. 41, No. 9, 1969, pp. 1586-1601.
- Waldichuk, M. Some Biological Concerns in Heavy Metals Pollution. *Pollut. Physiol. Mar. Org.*, 1974.
- Walker, G., P. S. Rainbow, P. Foster, and D. J. Crisp. Barnacles: Possible Indicators of Zinc Pollution. *Mar. Biol.*, v. 30, 1975, pp. 57-65.
- Ward, G. S., T. A. Hollister, P. T. Heitmuller, and P. R. Parrish. Acute and Chronic Toxicity of Selenium to Estuarine Organisms. *Northeast Gulf Sci.*, v. 4, 1981, pp. 73-78.
- Ward, T. J., and P. C. Young. Effects of Sediment Trace Metals and Particles Size on the Community Structure of Epibenthic Seagrass Fauna Near a Lead Smelter, South Australia. *Mar. Ecol. Prog. Ser.*, v. 9, 1982, pp. 137-146.
- Warnick, S. L. and H. L. Bell. The Acute Toxicity of Some Heavy Metals to Different Species Aquatic Insects. *J. Water Pollut. Control Fed.*, v. 41, 1969, pp. 280-284.
- Warren, L. J. Effects of Lead on Aquatic Life. Ch. in *Environ. Lead - Proc. Int. Symp., Environ. Lead Res.*, ed. by D. R. Lynman, and L. G. Piantanida, 1991, pp. 309-332.
- Warren, L. J., and R. W. Sheldon. Association Between *Pandalus borealis* and Fine-Grained Sediments off Northumberland. *Nature (London)*, v. 217, No. 5128, 1968, pp. 579-580.
- Watling, H. R. Comparative Study of the Effects of Zinc, Cadmium, and Copper on Larval Growth of Three Oyster Species. *Bull. Environ. Contam. Toxicol.*, v. 28, 1982, pp. 195-201.
- Wiebe, P. H., G. D. Grice, and E. Hoagland. Acid-Iron Waste as a Factor Affecting the Distribution and Abundance of Zooplankton in the New York Bight. II. Spatial Variation in the Field and Implications for Monitoring Studies. *Estuarine Coastal Mar. Sci.*, v. 1, 1973, pp. 51-64.
- Wildish, D. J., A. J. Wilson, and H. Akagi. Avoidance of Herring of Suspended Sediments From Dredge Spoil Dumping. *Int. Counc. Explor. Sea, C. M.*, v. E, 1977, p. 11.
- Winiacki, C. I. Community Recovery Trends Following a Benthic Disturbance in Boca de Quadra. *AK Prog. Rep.*, 1983, 47 pp.
- Winiacki, C. I. and Burrell. Growth of *Macoma balthica* on Mine Tailings Substrate. *Rep., Inst. of Mar. Sci., Univ. of AK, Fairbanks*, 1982.
- Winiacki, C. I., and C. D. Burrell. Benthic Community Development and Seasonal Variations in an Alaskan Fjord. Ch. in *Proc. 19th Eur. Mar. Biol. Symp.*, ed. by P. E. Gibb, Univ. Press, Cambridge, U.K., 1985, pp. 299-309.
- Winiacki, Carol I. December 1983 Progress Report on Community Recovery Trends Following a Benthic Disturbance in Boca de Quadra, Alaska. 1983.
- Wisely, B. and R. A. P. Blick. Mortality of Marine Invertebrates Larvae in Mercury, Copper and Zinc Solutions. *Aust. J. Mar. Freshwater Res.*, v. 18, 1967, pp. 63-72.
- Wong, M. H., S. K. Ho, K. W. Lai, and M. W. Li. An Ecological Survey of the Mycoflora in the Iron Ore Tailings. *J. Environ. Sci. Health*, v. A13, 1978, pp. 33-46.

- Wong, M. H., and M. W. Li. An Ecological Survey of the Heavy Metal Contamination of the Edible Clam *Paphia* Sp. on the Iron Ore Tailings of Tolo Harbour, Hong Kong. *Hydrobiol.*, v. 56, 1977, pp. 265-272.
- Wong, M. H., K. Y. Chan, S. H. Kwan, and C. F. Mo. Metal Content of the Two Marine Algae Found on Iron Ore Tailings. *Mar. Pollut. Bull.*, v. 10, 1979, pp. 56-59.
- Wright, P. J., and J. H. Weber. Biosorption of Inorganic Tin and Methyltin Compounds by Estuarine Microalgae. Ch. in *Environ. Sci. and Tech.*, Am. Chem. Soc., Washington, D.C., v. 25, No. 2, 1991, pp. 287-294.
- Yonge, C. M. On The Structure and Adaptations of the Tellinacea, Deposit Feeding Eulamellibranchia. *Phil. Trans. of the Royal Soc.*, v. 234, 1949, pp. 29-76.
- Young, D. R. Methods of Evaluating Pollutant Biomagnification in Marine Ecosystems. *Proc. Workshop on Meaningful Measures of Mar. Pollut. Effects*, Pensacola, FL, 1982.
- Young, D. R., A. J. Mearns, T. K. Jan and R. P. Eganhouse. The Cesium-Potassium Ratio and Trace Metal Biomagnification in Two Contaminated Marine Food Webs. *Proc. Oceans 81*, IEEE Washington, D. C., 1981.
- Young, D. R., and D. V. Ellis. A Note On Trace Metal Bioaccumulation and Biomagnification in Near-shore Marine Food Webs. Ch. in *Mar. Tailings Disposal*, ed. by D. V. Ellis, Ann Arbor Sci., 1982, pp. 133.
- Zamuda, C. D. and W. G. Sunda. Bioavailability of Dissolved Copper to the American Oyster *Crassostrea Virginica*. I. Importance of Chemical Speciation. *Mar. Biol.*, v. 66, 1982, pp. 77-82.

Chemical Citations

Aston, S. R., and R. Chester. The Influence of Suspended Particles on the Precipitation of Iron in Natural Waters. *Estuarine and Coastal Mar. Sci.*, v. 1, 1973, pp. 225-231.

Atlas, E., G. Martinez, and C. A. Giam. Chemical Characterization of Ocean Dumped Waste Materials. Ch. in *Ocean Dumping of Ind. Wastes*, ed. by B. H. Ketchum, R. D. Kester and P. K. Park, 1981.

Atmore, M. G. Schemes for Reducing Discoloration of Sea at Umbagaba Minerals. *S. African Min. and Eng. J.*, v. 76, No. 3770, 1965, 10512 pp.

Balzer, W. Redox Dependant Processes in the Transition from Oxic to Anoxic Conditions: an In-Situ Study Concerning Remineralization, Nutrient Release and Heavy Metal Solubilization. Ch. in *Fjord Oceanogr.*, ed. by H. J. Freeland, D. M. Farmer, and C. D. Levings, Plenum, 1980.

Batley, G. E. Electroanalytical Techniques for the Determination of Heavy Metals in Seawater. *Mar. Chem.*, v. 12, No. 2-3, 1983, pp. 107-117.

Baumgartner, D. J., D. W. Shults and J. B. Carkin. Aquatic Disposal Field Investigations, Duwamish Waterway Disposal Site, Puget Sound, Washington. Appendix D. Chemical and Physical Analyses of Water and Sediment in Relation to Disposal of Dredged Material in Elliott Bay, February-June 1976. Washington Univ. Seattle Lab. of Radiation Ecol., WESTR-D-77-24-APPL- D. See also V. 2, AD/A058 001 and Appendix C, AD-A049 616, v. 2, 1978, 221 pp.

Bender, M. L. Nearshore Marine Trace Metal Geochemistry. EPA 600/S3-81-050, 1982.

Benjamin, M. M., and J. D. Lecki. Adsorption at Oxide Interfaces: Effects of the Concentrations of Adsorbate and Competing Metals. *Contaminants and Sediments, Anal., Chem., Biol., Ann Arbor Sci.*, v. 2, 1980, pp. 305-322.

Berrang, P. G., and E. V. Grill. The Effect of Manganese Oxide Scavenging on Molybdenum in Saanich Inlet, British Columbia. *Mar. Chem.*, v. 2, No. 2, 1974, pp. 125-148.

Bertine, K. K. The Deposition of Molybdenum in Anoxic Waters. *Mar. Chem.*, v. 1, 1972, pp. 43-53.

Bertine, K. K., and K. K. Turekian. Molybdenum in Marine Deposits. *Geochim. Cosmochim. Acta*, v. 37, No. 6, 1973, pp. 1415-1434.

Bindra, K. S. Mobilization of Selected Trace Metals in the Aquatic Environment (Sediment to Water Column and Benthic Invertebrates). Ph.D. Thesis, Univ. of B. C., Canada, 1983.

Bloom, N. S., and E. A. Creelius. Determination of Mercury in Seawater at Subnanogram per Liter Levels. *Mar. Chem.*, v. 14, 1983, pp. 49-59.

Bollingberg, H. J. Geochemical Prospecting Using Seaweed, Shellfish and Fish. *Geochim. and Cosmochim. Acta*, v. 39, 1975, pp. 1567-1570.

Boulegue, J. Trace Metals (Fe, Cu, Zn, Cd) in Anoxic Environments. Ch. in *Trace Metals in Seawater*, ed. by C. S. Wong, et al, NATO Sci. Affairs Div., Plenum, 1983, pp. 563-577.

Bourg, A. C. M. Role of Freshwater/Seawater Mixing on Trace Metal Absorption Phenomena. Ch. in *Trace Metals in Seawater*, ed. by C. S. Wong, et al. NATO Sci. Affairs Div., Plenum, 1983, pp. 195-208.

Bray, J. T., O. P. Bricker, and B. N. Troup. Phosphate in Interstitial Waters of Anoxic Sediments: Oxidation Effects During Sampling Procedure. *Sci.*, v. 180, 1973, pp. 1362-1364.

Brooks, R. R., B. J. Presley, and I. R. Kaplan. Trace Elements in the Interstitial Waters of Marine Sediments. *Geochim. et. Cosmochim. Acta*, v. 32, 1968, pp. 397-414.

- Brown, B. E., and R. C. Newell. The Effect of Copper and Zinc on the Metabolism of Mussel, *Mytilus Edulis*. *Mar. Biol.*, v. 16, 1972, pp. 108-118.
- Brugmann, L. Electrochemical Speciation of Trace Metals in Sea Water. *Sci. Total Environ.*, v. 37, No. 1, 1984, pp. 41-60.
- Brugmann, L., L. G. Danielsson, B. Magnusson, and S. Westerlund. Intercomparison of Different Methods for the Determination of Trace Metals in Seawater. *Mar. Chem.*, v. 13, No. 4, 1983, pp. 327-338.
- Bruland, K. W. Oceanographic Distributions of Cadmium, Zinc, Nickel, and Copper in the North Pacific. *Earth and Planetary Sci. Letters*, v. 47, 1980, pp. 176-198.
- Bruynesteyn, A., and R. P. Hackl. Evaluation of Acid Production Potential of Mining Waste Materials. *Min. and the Environ.*, v. 4, 1982, pp. 5-8.
- Burrell, D. C. Trace Metal Associations in Sub-Arctic Fjord Environments, RLO-2229-T1-34, Progress Report, April 1975 - March 1976. U. S. Energy Res. and Develop. Admin., 1976.
- Burrell, D. C. and D. T. Heggie. Patterns of Oxygen Supply and Consumption in Two Alaskan Fjord Basins. 11th Int. Congr. Sediment., Hamilton, Ontario, 1982.
- Burton, J. D. Physico-Chemical Limitations in Experimental Investigations. *Phil. Trans. R. Soc. Lond. B.*, v. 286, 1979, pp. 443-456.
- Chao, T. T., and L. Zhou. Extraction Techniques for Selective Dissolution of Amorphous Iron Oxides From Soils and Sediments. Ch. in *J., Soil Sci. Soc. of Am., Madison, WI.*, v. 47, 1983, pp. 225-232.
- Chave, K. E. Chemical Reactions and the Composition of Seawater. *J. Chem. Educ.*, v. 48, No. 3, 1971, pp. 148-151.
- Chou, T. T. Use of Partial Dissolution Techniques in Geochemical Exploration. Ch. in *J. of Geochem. Expl., Elsevier Sci.*, v. 20, 1984, pp. 101-135.
- Christophersen, N., R. D. Vogt, C. Neal, H. A. Anderson, R. C. Ferrier, J. D. Miller, and H. M. Seip. Controlling Mechanisms for Water Chemistry at the Pristine Ingabekken Site in Mid-Norway: Some Implications for Acidification Models. Ch. in *Water Resour. Res., Am. Geophys. Union, Washington, D. C.*, v. 26, No. 1, 1990, pp. 59-67.
- Contreral, R., T. R. Fogg, N. D., Chasteen, H. E. Gaudette, and W. B. Lyons. Molybdenum in the Pore Waters of Anoxic Marine Sediments By Electron Paramagnetic Resonance Spectroscopy. *Mar. Chem.*, v. 6, 1978, pp. 365-373.
- Cornwell, J. C., and J. W. Morse. The Characterization of Iron Sulfide Minerals in Anoxic Marine Sediments. Ch. in *Mar. Chem., Elsevier Sci.*, v. 22, 1987, pp. 193-206.
- Danielsson, L., B. Magnusson, and S. Westerlund. An Improved Metal Extraction Procedure for the Determination of Trace Metals in Seawater by Atomic Absorption Spectrometry With Electrothermal Atomization. *Anal. Chim. Acta*, v. 98, 1978, pp. 47-57.
- De Kreuk, J. F., and A. O. Hanstveit. Determination of the Biodegradability of the Organic Fraction of Chemical Wastes. *Chemosphere*, v. 10, No. 6, 1981, pp. 561-573.
- DeGroot, A. J., and E. Allersma. Field Observations on the Transport of Heavy Metals in Sediment. Ch. in *Heavy Metals in the Aquat. Environ.*, ed. by P. A. Krenkel, Pergamon, 1975, pp. 85-95.
- Domagalski, J. L., H. P. Eugster, and B. F. Jones. Trace Element Geochemistry of Walker, Mono, and Great Salt Lakes in Fluid-Mineral Interactions: A Tribute to H. P. Eugster. Ch. in *Geochem. Soc.*, ed. by R. J. Spencer, and I-Ming Chou, Special Pub., No. 2, 1990, pp. 315, 319, 320.

- Dossi, P., and L. J. Warren. Distribution of Heavy Metals Between the Minerals and Organic Debris in a Contaminated Marine Sediment. Ch. in *Contam. and Sediments, Fate and Transport, Case Studies, Modeling, Toxicity*, ed. by R. A. Baker, Ann Arbor Sci., 1980, pp. 119-139.
- Duncan, D. W., and C. C. Waldon. Measurement of Acid-Producing Potential. Prepared for the Dep. of the Environ. by B. C. Res., 1972.
- Eganhouse, R. P., D. R. Young and J. N. Johnson. Geochemistry of Mercury in Palos Verdes Sediments. *Environ. Sci. & Tech.*, v. 12, 1978, pp. 1151-1157.
- El-Enany, F., K. F. Mahmoud, and M. M. Man. Single Organic Extraction for Determination of Ten Heavy Metals in Sea Water. *J. Water Pollut. Control Fed.*, v. 51, 1979, p. 2545.
- Emerson, S., and G. Widmer. Early Diagenesis in Anaerobic Lake Sediments-II. Thermodynamic and Kinetic Factors Controlling the Formation of Iron Phosphate. *Geochim. et Cosmochim. Acta.*, v. 42, 1978, pp. 1307-1316.
- Emerson, S., L. Jacobs, and B. Tebo. The Behavior of Trace Metals in Marine Anoxic Waters: Solubilities at the Oxygen-Hydrogen Sulfide Interface. Ch. in *Trace Metals in Seawater*, ed. by C. S. Wong, NATO Sci. Affairs Div., Plenum, 1983, pp. 579-608.
- Erickson, P. and V. Stukas. Trace Metals in Boca de Quadra, Alaska, Using the Vacuum Intercept Pumping System. *Seakem Oceanogr., Ltd.*, Rep. Submitted to United States Borax & Chem. Corp., 1983, 25 pp.
- Farrington, J. W., E. D. Goldberg, R.W. Risebrough, J. H. Martin, and V. T. Bowen. Mussel Watch 1976-1978: An Overview of the Trace-Metal, DDE, PCB, Hydrocarbon, and Artificial Radionuclide Data. *Environ. Sci. & Tech.*, v. 17, No. 8, 1983, pp. 490.
- Ferguson, J. F., and L. Vrale. Chemical Aspects of the Lime Seawater Process. *J. Water Pollut. Control Fed.*, v. 56, No. 4, 1984, pp. 355-363.
- Fitzgerald, W. F. Mercury Concentrations in Seawater and Rain: Geochemical Implication. Ch. in *Mar. Pollut. Transfer*, ed. by H. Windom, and R. Duce. D. C. Health Pub., 1976.
- Galloway, J. N. Alteration of Trace Metal Geochemical Cycles Due to the Marine Discharge of Waste Water. *Geochim. Cosmochim. Acta.*, v. 43, No. 2, 1979, pp. 207-218.
- Gambrell, R. P., R. A. Khalid, and W. J. Patrick, Jr. Chemical Availability of Mercury, Lead, and Zinc in Mobile Bay Sediment Suspensions as Affected by pH and Oxidation-reduction Conditions. *Environ. Sci. & Tech.*, v. 14, No. 4, 1980, pp. 431-436.
- Garrels, R. M., and C. L. Christ. *Solution, Minerals, and Equilibria*. Harper & Row, 1964, 450 pp.
- Gieskes, J. M., and W. C. Rogers. Alkalinity Determination in Interstitial Waters of Marine Sediments. *J. of Sedimentary Petrology*, v. 43, 1973, pp. 272-277.
- Gramm-Osipov, L. M., and O. A. Kiseleva. Distribution of Copper, Zinc, Lead, Molybdenum, and Tungsten in Bottom Sediments of the Pacific Ocean. *Vopr. Geol., Geokhim. Metall. Sev. -Zap. Seklora Tikhookean Poyasa*, (Russ.) From *Ref. Zh., Geol.*, V. Abstr. No. 1V79, (1971), 1970, pp. 213-218.
- Gupta, S. K., and K. Y. Chen. Partitioning of Trace Metals in Selective Chemical Fractions of Nearshore Sediments. *Environ. Letter*, v. 10, 1975, pp. 129-158.
- Hannaker, P., and T. C. Hughes. Improved Stepwise Solvent Extraction Scheme for Geochemical Trace Analysis Using Flame Atomic Absorption. Ch. in *J. of Geochem. Expl.*, Elsevier Sci., v. 10, 1978, pp. 169-180.
- Heggie, D. T., and D. C. Burrell. Sediment-Seawater Exchanges of Nutrients and Transition Metals in an Alaskan Fjord. Ch. in *Fjord Oceanogr.*, ed. by H. J. Freeland, D. M. Farmer, and C. D. Levings, Plenum, 1980, pp. 675-680.

- Hem, J. D. Study and Interpretation of the Chemical Characteristics of Natural Water. U. S., Water Supply Paper 1473, 1975.
- Holm, T. R., and C. D. Curtiss. A Comparison of Oxidation-Reduced Potentials Calculated From the As(V)/As(III) and Fe(III)/Fe(II) Couples With Measured Platinum-Electrode Potentials in Groundwater. Ch. in J. of Contam. Hydrol. Elsevier Sci., v. 5, 1989, pp. 67-81.
- Hong, G. H. Fluxes, Dynamics and Chemistry of Particulate Matter in SE Alaska Fjord. Univ. of AK., 1986.
- Hoos, R. A. W., and W. N. Holman. Pacific Region Mine Effluent Chemistry and Acute Toxicity Survey. Env. Prot. Serv. Pac. Reg. Rep. EPS 5-PR-73-10, 1973, 41 pp.
- Horne, R. A. Suspended Particulate Matter in Seawater Marine Chemistry: The Structure of Water and the Chemistry of the Hydrosphere. Wiley, 1969, pp. 224-237.
- Horne, R. A. Marine Chemistry. Wiley, 1969.
- Howarth, R. A Rapid and Precise Method for Determining Sulphate in Seawater, Estuarine Waters and Sediment Pore Waters. Limnol. and Oceanogr., v. 23, 1978, pp. 1066-1069.
- Jaffe, D., and K. J. Walters. Intertidal Trace Metal Concentrations in Some Sediments From the Humber Estuary. Sci. Total Environ., v. 7, 1977, pp. 1-15.
- Jeffery J., N. Marshman, and W. Salomons. Behavior of Trace Metals in a Tropical River System Affected by Mining. Ch. in Chem. and Biol. of Solid Waste, ed. by W. Salomons and U. Forstner, Springer, 1988, pp. 259-274 (396 pp).
- Jeffery, J. A Survey of Heavy Metal Concentrations in Empress Augusta Bay. BCM Rep. RB 258, 1984.
- Jones, G. B. Molybdenum in a Nearshore and Estuarine Environment, North Wales. Estuarine and Coastal Mar. Sci., v. 2, No. 2, 1974, pp. 185-189.
- Jones, P. G. W. International Intercalibration of Techniques for Measuring Trace Metals in Sea Water. Anal. Proc., v. 19, 1982, pp. 565.
- Jouanneau, J. M., H. Etcheber, and C. Latouche. Impoverishment and Decrease of Metallic Elements Associated with Suspended Matter in the Gironde Estuary. Ch. in Trace Met. in Seawater, ed. by C. S. Wong, et al, NATO Sci. Affairs Div., Plenum, 1983, pp. 245-263.
- Kim, Y. S. and H. Zeitlan. The Determination of Molybdenum in Sea Water. Limnol. Oceano., v. 13, 1968, pp. 534-537.
- Kim, Y. S., and H. Zeitlin. Separation of Trace Metal Ions in Sea Water by Adsorptive Colloid Flotation. Chem. Commun., 1971, p. 672.
- Kim, Y. S., and H. Zeitlin. The Separation of Zinc and Copper From Sea Water by Adsorptive Colloid Flotation. Separ. Sci., v. 7, 1972, pp. 1-12.
- Kloocking, R. Enhancement and Decrease of Heavy Metal Toxicity by Humic Acids. Arch. Exp. Veterinaermed, v. 34, No. 3, 1980, pp. 389-393.
- Klopffer, W. G. Rippen, and R. Frische. Physicochemical Properties as Useful Tools for Predicting the Environmental Fate of Organic Chemicals. Ecotoxicol. Environ. Safety, v. 6, 1982, pp. 294.
- Kremling, K., A. Wenck, and C. Osterroht. Variations of Dissolved Organic Copper in Marine Waters. Ch. in Trace Met. in Seawater, ed. by C. S. Wong, et al, NATO Sci. Affairs Div., Plenum, 1983, pp. 609-620.
- Lee, G. F., and J. M. Lopez. Environmental Chemistry of Copper in Torch Lake, Michigan. Water, Air and Soil Pollut., v. 8, No. 4, 1977, pp. 373-385.

- Lerman, A., D. Lal, and M. F. Dacey. Stokes' Settling and Chemical Reactivity of Suspended Particles in Natural Waters. Ch. in *Suspended Solids in Water*, ed. by R. J. Gibbs, 1974, 17 pp.
- Letourneau, V. A., B. M. Joshi, and L. C. Butler. Comparison Between Zeeman and Continuum Background Correction for Graphite Furnace AAS on Environmental Samples. Ch. in *Atomic Spectrosc.*, Perkin-Elmer Corp., Norwalk, CT., v. 8, No. 5, 1987, pp. 145-149.
- Li, Y. H., and S. Gregory. Diffusion of Ions in Sea Water and in Deep-Sea Sediments. *Geochim. Cosmochim. Acta.*, v. 38, 1974, pp. 703-714.
- Lindberg, S. E., A. W. Andren, and R. C. Harriss. Geochemistry of Mercury in the Estuarine Environment. *Estuarine Res.*, v. 1, 1975, pp. 64-107.
- Lu, J. C. S., and K. Y. Chen. Migration of Chemical Constituents in Sediment-Seawater Interfaces. Ch. in *Chem. of Mar. Sediments*, ed. by T. F. Yen, Ann Arbor Sci., 1977.
- Lyons, W. B., and W. F. Fitzgerald. Trace Metals Speciation in Nearshore Anoxic and Suboxic Pore Waters. Ch. in *Trace Met. in Seawater*, ed. by C. S. Wong, et al, NATO Sci. Affairs Div., Plenum, 1983, pp. 621-641.
- MacCarthy, P. and R. W. Klusman. Water Analysis. Ch. in *Analyt. Chem.*, Am. Chem. Soc., Washington, D. C., v. 59, No. 12, 1987, pp. 308R-337R.
- MacDonald, R. W., M. C. O'Brien, and D. M. MacDonald. Ocean Chemistry Data Report: Alice Arm, Observatory Inlet; Part 3, September - October 1982. *Can. Data Rep. Hydro Ocean Sci.*, No. 17, 1984.
- MacDonald, R. W., M. C. O'Brien, and D. M. MacDonald. Ocean Chemistry Data Report: Alice Arm, Observatory Inlet; Part 1, December 1981, January 1982, June 1982, January 1983. *Can. Data Rep. Hydro. Ocean Sci.*, No. 17, 1984.
- MacDonald, R. W., M. C. O'Brien, and D. M. MacDonald. Ocean Chemistry Data Report: Alice Arm, Observatory Inlet; Part 2, March 1982. *Can. Data Rep. Hydro. Ocean Sci.*, No. 17, 1984.
- Magnusson, B., and S. Westerlund. Trace Metal Levels in Seawater from the Skagerrak and the Kattegat. Ch. in *Trace Metals in Seawater*, ed. by C. S. Wong, et al, NATO Sci. Affairs Div., Plenum, 1983, pp. 1983.
- Majima, H., and E. Peters. Electrochemistry of Sulphide Dissolution in Hydrometallurgical Systems. Paper E-1, Proc. VIII Int. Miner. Processing Congr., Leningrad, v. 2, 1968, p. 5.
- Malcolm, R. S., and D. C. Burrell. Composition and Manganese Association of Suspended Matter at the Head of a Southeast Alaskan Fjord. *Inst. of Mar. Sci., Univ. of AK, Fairbanks*, 1981.
- Manheim, F. T. Diffusion of Ions in Unconsolidated Sediments. *Earth Planet. Sci. Letter*, v. 9, 1970, pp. 307-309.
- Mart, L., H. W. Nurnberg, and D. Dryssen. Low Level Determination of Trace Metals in Arctic Seawater and Snow by Differential Pulse Anodic Stripping Voltammetry. Ch. in *Trace Metals in Seawater*, ed. by C. S. Wong, et al, NATO Sci. Affairs Div., Plenum, 1983, pp. 113-130.
- Martin, J. M., P. Nirel, and A. J. Thomas. Sequential Extraction Techniques: Promises and Problems. Ch. in *Mar. Chem.*, Elsevier Sci., v. 22, 1986, pp. 313-341.
- McIlhenny, W. F., and M. A. Zeitoun. A Chemical Engineer's Guide to Seawater Part 2. *Chem. Eng.*, v. 76, No. 25, 1969, pp. 251-256.
- Mok, M. W., and C. M. Wai. Simultaneous Extraction of Trivalent and Pentavalent Antimony and Arsenic Species in Natural Waters for Neutron Activation Analysis. Ch. in *Analyt. Chem.*, Am. Chem. Soc., Washington, D. C., v. 59, No. 2, 1987, pp. 233-236.
- Mok, M. W., J. A. Riley, and C. M. Wai. Arsenic Speciation and Quality of Groundwater in a Lead-Zinc Mine, Idaho. Ch. in *Water Res.*, Pergamon, Oxford, UK, v. 22, No. 6, 1988, pp. 769-774.

- Moore, R. M. The Relationship Between Distributions of Dissolved Cadmium, Iron and Aluminum and Hydrology in the Central Arctic Ocean. Ch. in Trace Metals in Seawater, ed. by C. S. Wong, et al, NATO Sci. Affairs Div., Plenum, 1983, pp. 131-142.
- Muhammad, A. Instrumental Analysis for the Determination of Mercury. Dep. of Geol., Eastern Washington Univ., Cheney, WA., 1989, 19 pp.
- Muller, F. L. L., and D. R. Kester. Kinetic Approach to Trace Metal Complexation in Seawater: Application to Zinc and Cadmium. Ch. in Environ. Sci. and Technol., Am. Chem. Soc., Washington, D.C., v. 24, No. 2, 1990, pp. 234-242.
- Murray, S. M. and T. L. Ku. Recent Deposition of Lead off the Coast of Southern California. Ch. in Chem. of Mar. Sediments, ed. by T. F. Yen, Ann Arbor Sci., 1977.
- Newell, A. D., and J. G. Sanders. Relative Copper Binding Capacities of Dissolved Organic Compounds in a Coastal-Plain Estuary. Environ. Sci. Technol., v. 20, 1986, pp. 817-821.
- O'Connor, T. D., and D. R. Kester. Adsorption of Copper and Cobalt From Fresh and Marine Systems. Geochim. Cosmochim. Acta., v. 39, 1975, pp. 1531-1543.
- Oakley, S. N., P. O. Nelson, and K. J. Williamson. Model of Trace Metal Partitioning in Marine Sediments. Environ. Sci. Technol., v. 15, 1981, pp. 474-480.
- Owens, T. L., D. C. Burrell, and H. V. Weiss. Reaction and Flux of Manganese Within the Oxidic Sediment and Basin Water of an Alaskan Fjord. Ch. in Fjord Oceanogr., ed. by H. J. Freeland, D. M. Farmer, and C. D. Levings, Plenum, 1980, pp. 667-673.
- Pavlou, S. P. and D. P. Weston. Initial Evaluation of Alternatives for Development of Sediment Related Criteria for Toxic Contaminants in Marine Waters (Puget Sound) Part II: Development and Testing of the Sediment-Water Equilibrium Partitioning Approach. Draft Rep. Prepared for the U. S. EPA, Submitted to Water Qual. Branch, EPA X, Contract No. 68-01-6388, 1984, 84 pp.
- Pedersen T. F. Early Diagenesis of Copper and Molybdenum in Mine Tailings and Natural Sediments in Rupert and Holberg Inlets, British Columbia. Can. J. Earth Sci., v. 22, No. 10, 1985, pp. 1474-1484.
- Pedersen, T. F. Interstitial Water Metabolite Chemistry in a Marine Mine Tailing Deposit, Rupert Inlet. Can. J. Earth Sci., v. 21, No. 1, 1984, pp. 1-9.
- Pedersen, T. F. Dissolved Heavy Metals in a Lacustrine Mine Tailings Deposit -- Buttle Lake, British Columbia. Mar. Pollut. Bull., v. 14, No. 7, 1983, pp. 249-254.
- Pedersen, T. F., and A. J. Losher. Diagenetic Processes in Aquatic Mine Tailings Deposits in British Columbia. Ch. 10 in Chem. and Biol. of Solid Waste, ed. by W. Salomons and U. Forstner, Springer, 1988, pp. 238-258.
- Pedersen, T. F., B. Mueller, C. A. Pelletier. On the Reactivity of Submersed Mine Tailings in Fjords and a Lake in British Columbia. Pres. at GAC Spec. Symp. on Acid Mine Waste, 1990, 9 pp.
- Plumb, R. H., and G. F. Lee Jr. Oxygen Demand of Taconite Tailings. J. Water Pollut. Center Fed., v. 55, No. 3, 1983, pp. 317-332.
- Presley, B. J., Y. Kolodny, A. Nissenbaum, and I. R. Kaplan. Early Diagenesis in a Reducing Fjord, Sannich Inlet, B. C. - II, Trace Element Distribution in Interstitial Water And Sediment. Geochim., Cosmochim. Acta, v. 36, 1972, pp. 1073.
- Rao, S. R., and L. G. Hepler. Equilibrium Constants and Thermodynamics of Ionization of Aqueous Hydrogen Sulfide. Hydrometallurgy, v. 2, 1976, pp. 293-299.
- Rashid, M. A. Absorption of Metals on Sedimentary and Peat Humic Acids. Chem. Geol., v. 13, 1974, pp. 115-123.

- Ray, S., and W. White. Some Observations on Heavy Metal Concentration in Northeastern New Brunswick Estuarine Surficial Sediments. *Can. Fish. Mar. Serv. Tech. Rep.*, v. 696, 1977, pp. 1-23.
- Rescan Environmental Services, Ltd. Dissolved Metal Levels in Alice Arm. Rescan Environ. Serv., Ltd., Prepared for Amax of Canada Ltd., 1982.
- Riley, J. P., and G. Skirrow. *Chemical Oceanography*. Academic, 1965.
- Riley, J. P., and R. Chester. *Introduction to Marine Chemistry*. Academic, 1971, p. 92.
- Rohatgi, N., and K. Y. Chen. Transport of Trace Metals by Suspended Particulates on Mixing with Seawater. *J. Water Pollut. Control Fed.*, v. 47, No. 9, 1975, pp. 2298-2316.
- Schein, D. B., V. K. Nakahara, and H. Zeitlin. Seawater Leaching of Trace Metals From Processed Ferromanganese Nodule Wastes. *Mar. Min.*, v. 6, No. 1, 1987, pp. 71-78.
- Scrudato, R. J., and E. L. Estes. Clay-Lead Sorption Relations. *Environ. Geol.*, v. 1, No. 3, 1975, pp. 167-170.
- Shreedhara Murthy, R. S., and D. E. Ryan. Determination of Arsenic, Molybdenum, Uranium, and Vanadium in Seawater by Neutron Activation Analysis After Preconcentration by Colloid Flotation. *Anal. Chem.*, v. 55, 1983, pp. 682-684.
- Shuman, L. M. Fractionation Method for Soil Microelements. Ch. in *Soil Sci.*, Williams and Wilkins Co., v. 140, No. 1, 1985, pp. 11-22.
- Skei, J. M. Fluxes of Pollutants to Norwegian Fjord Sediments Based on Lead-210. Ch. in *Mar. Chem. into the Eighties*, ed. by J.A.J. Thompson and W. D. Jamieson, Symp. Proc., Victoria, B.C. Canada, May 31 - Jun. 11, 1979.
- Skei, J., and P. E. Paus. Surface Metal Enrichment and Partitioning of Metals in a Dated Sediment Core from a Norwegian Fjord. *Geochim. Cosmochim. Acta.*, v. 43, 1979, pp. 239-246.
- Skougstad, M. W., M. J. Fishman, L. C. Friedman, D. E. Erdmann, and S. S. Duncan. Iron, Ferrous, Dissolved, Colorimetric, Bipyridine (I-1388-78). Ch. in *Techniques of Water-Resour. Investigations of the United States Geol. Surv.*, Ch. A1, Methods for Determination of Inorganic Substances in Water and Fluvial Sediments, Bk. 5, Lab. Anal., pp. 387-388.
- Sperling, K. R. Determination of Heavy Metals in Seawater and in Marine Organisms by Flameless Atomic Absorption Spectrophotometry. XVII. On the Usefulness of Signal Integration--A Warning. *Fresenius, Z. Anal. Chem.*, v. 314, No. 4, 1983, pp. 417-418.
- Speyer, M. R. Mercury and Selenium Concentrations in Fish, Sediments Water of Two Northwestern Quebec Lakes. *Bull. Environ. Contam. Toxicol. Can.*, v. 24, No. 3, 1980, pp. 427-432.
- Springer - Verlag. *Chemistry and Biology of Solid Waste; Dredged Material and Mine Tailings*. V. 10, 1988, 305 pp.
- Stauber, J. L., and T. M. Florence. Interactions of Copper and Manganese: A Mechanism by Which Manganese Alleviates Copper Toxicity to the Marine Diatom, *Nitzschia Closterium* (Ehrenberg). *W. Smith, Aquat. Toxicol.*, v. 7, 1985, pp. 241-254.
- Stern, D. A., and C. L. Grant. A Laboratory Investigation of Heavy Metal Absorption on Marine Dredge Spoils. *Bull. Environ. Contam. Toxicol.*, v. 26, 1981, pp. 213-218.
- Strickland, J. D. H., and T. R. Parsons. *A Practical Handbook of Seawater Analysis*. Fish. Res. Bd. Can. Bull., 1972, pp. 167.
- Stukas, V. J., and C. S. Wong. Application of Isotope Dilution Mass Spectrometry to the Determination of Copper, Cadmium, Lead, Zinc, Nickel, Iron and Chromium in Seawater. *Mar. Chem.*, v. 12, No. 2-3, 1983, pp. 133-146.

- Stukas, V. J., and C. S. Wong. Accurate and Precise Analysis of Trace Levels of Cu, Cd, Pb, Zn, Fe and Ni in Seawater by Isotope Dilution Mass Spectrometry. Ch. in Trace Metals in Seawater, ed. by C. S. Wong, NATO Sci. Affairs Div., Plenum, 1983, pp. 513-536.
- Sugai, S.F. Processes Controlling Trace Metal and Nutrient Geochemistry in Two Southeast Alaskan Fjords. Thesis, 1985.
- Taylor, B. E., M. C. Wheeler, and D. K. Nordstrom. Isotope Composition of Sulfate in Acid Mine Drainage as a Measure of Bacterial Oxidation. Ch. in Nature, Macmillan Publ. Ltd., London, UK., v. 308, No. 5, 1984, pp. 538-541.
- Thompson, J. A. J. and D. W. Paton. Copper in Sediment Interstitial Waters and Overlying Waters of Howe Sound, B. C. Tech. Rep., Fish. and Mar. Serv. (Canada), No. 775, 1978, 29 pp.
- Thompson, J. A. J., and J. A. Crerar. Methylation of Lead in Marine Sediments. Mar. Poll. Bull., v. 11, 1980, pp. 251-253.
- Thompson, J. A. J., and W. D. Jamieson. Marine Chemistry into the Eighties. Symp. Proc., Victoria, B. C. Canada, 1979.
- Thompson, J. A. J., D. W. Paton, and M. Timmons. Copper and Zinc in Sediments of Georgia Strait, B. C., in the Vicinity of Texada Mine. Pac. Mar. Sci. Rep. 79-17, 1979, 13 pp.
- Thompson, J. A. J., J. C. Davis, and R. E. Drew. Toxicity Uptake and Survey Studies of Boron in the Marine Environment. Water Res., v. 10, 1976, pp. 869-875.
- Thornton, I. Geochemical Parameters in the Assessment of Estuarine Pollution. Ch. in The Ecol. of Res. Degradation and Renewal, ed. by M. J. Chadwick, and G. T. Goodman, 15th Symp. of The British Ecolog. Soc., Jul. 1-12, 1973, Blackwell Sci., 1975.
- Toppings, G. and I. M. Davies. Methylmercury Production in the Marine Water Column. Nature, v. 290, No. 5403, 1981, pp. 243-244.
- U. S. Environmental Protection Agency. Methods for Chemical Analysis of Water Wastes. Environ. Monitoring and Support Lab. EPA 600/4-79-020, 1979.
- Uzman, L. L. Histochemical Localization of Copper With Rubeanic Acid. Lab. Investigation, v. 5, 1956, pp. 299-305.
- Van den Berg, C. M. G. Trace Metal Speciation in Sea Water. Anal. Proc., v. 20, No. 9, 1983, pp. 458-460.
- Voice, T. C., and W. J. Weber Jr. Sorption of Hydrophobic Compounds by Sediments, Soils and Suspended Solids-I, Theory and Background. Water Res., v. 17, 1983, pp. 1433-1441.
- Wagemann, R. and J. Barcia. Speciation and Rate of Loss of Copper From Lake Water With Implications to Toxicity. Water Res., v. 13, 1979, pp. 515-523.
- Wastler, A., and C. K. Offutt. Chemical Needs for the Regulation of Ocean Disposal. Ch. in Mar. Chem. in the Coastal Environ., ed. by T. M. Church, ACS Symp., Ser. 18, Washington, D. C., 1975, pp. 416.
- Water Quality Standards Handbook. 1983.
- Williams, P. M., and K. S. Chan. Distribution and Speciation of Iron in Natural Water: Transition from River Water to a Marine Environment, B. C. Canada. J. Fish. Res. Board of Can., v. 23, 1966, pp. 575-593.
- Young, D. R. The Distribution of Cesium, Rubidium, and Potassium in the Quasi-Marine Ecosystem of The Salton Sea. Ph.D. Thesis, Univ. CA., San Diego, 1970.
- Zirino, A. and S. Yamamoto. A pH-Dependent Model for the Chemical Speciation of Copper, Zinc, Cadmium and Lead in Seawater. Limnol. Oceanogr., v. 17, 1972, pp. 661-671.

Zuehlke, R. W., and D. R. Kester. Copper Speciation in Marine Waters. Ch. in Trace Metals in Seawater, ed. by C. S. Wong, et al, NATO Sci. Affairs Div., Plenum, 1983, pp. 773-788.

Environmental Citations

Adams, W. J., R. A. Kimerle, and R. G. Mosher. Aquatic Safety Assessment of Chemicals Sorbed to Sediments. Ch. in *Aquat. Toxicol. and Hazard Assess., Seventh Symp.*, ed. by R. D. Cardwell, R. Purdym and R. C. Bahner, ASTM STP 854, 1985, pp. 429-453.

Alaska Department of Environmental Conservation. Alaska Water Quality Standards (Alaska Administrative Code, Title 18, Environmental Conservation, Chapters 70 and 80, Water Quality Standards). 1982.

Allen, O., and J. W. Hardy. Impacts of Navigational Dredging on Fish and Wildlife: A Literature Review. Rep. No. FWS/OBS-80/07, 1980.

Allon, G. W., and D. M. Conlon. Dredge Spoil Surveillance in Shellfish Areas. Proc. Conf. Civil Eng. in the Ocean II, 1969, pp. 823-834.

Amax of Canada Limited. Kitsault Mine Environmental Monitoring Program (AATDR, PE-4335). Annu. Rep. 1982. Vancouver, B. C., 1983.

American Society for Testing and Materials. Standard Guide for Assessing the Hazard of a Material to Aquatic Organisms and Their Uses. Annu. Book of ASTM Standards. Pesticides; Resour. Recovery; Hazardous Substances & Oil Spill Responses; Waste Disposal; Biol. Effects. ASTM, v. 11, No. 4, 1985, pp. 613-633.

Anderson, D. W., P. Doudoroff, and J. R. Oxberry. Potential Toxicity of Taconite Tailings to Aquatic Life in Lake Superior. *J. Water Pollut. Control Fed.*, v. 50, No. 2, 1978, pp. 240-251.

Applied Geology Associated Ltd. Environmental Socio-Economic Public Health Review, Bougainville Copper Mine, Panguna. New Zealand, 1989, 180 pp.

Archer, A. Sub-Sea Minerals and the Environment. *New Scientist*, v. 48, No. 728, 1970, pp. 372-373.

Ariathurai, R., R. C. MacArthur, and R. B. Drone. Mathematical Mode of Estuarial Sediment Transport. Tech. Rep. D-77-12, U.S. Army Waterways Experiment Station, Vicksburg, MS., 1977.

Asmund, G. Environmental Survey in Relation to Mining Operations at Marmorilik, Umanak District, Central West Greenland. *Rapport Gronlands Geologiske Undersogelse*, No. 75, 1975, pp. 46-47.

Asmund, G. Water Movements Traced by Metals Dissolved from Mine Tailings Deposited in a Fjord in North-West Greenland. Ch. in *Fjord Oceanogr.*, ed. by H. J. Freeland, D. M. Farmer, and C. D. Levings, Plenum, 1979, pp. 347-354.

Asmund, G., H. J. Bollingberg and Bondam. Continued Environmental Studies in the Quamarujuk and Agfardlikavsá Fjords, Marmorilik, Umanak District, Central West Greenland. *Rapport Gronlands Geologiske Undersogelse*, No. 80, 1975, pp. 53-61.

Asmund, G., P. Johansen, and B. W. Fallis. Disposal of Mine Wastes Containing Pb and Zn Near the Ocean: An Assessment of Associated Environmental Implications in the Arctic. *Greenland Environ. Res. Inst.*, 1989, p. 71.

Auble, G. T., A. K. Andrews, D. B. Hamilton, J. E. Roelle, and T. G. Shoemaker. A Workshop Model Simulating Fate and Effect of Drilling Muds and Cuttings on Benthic Communities. U. S. Fish & Wildlife Service. Western Energy and Land Use Team, Fort Collins, CO. WELUT-85/w02, 1984, 189 pp.

Ayers, R. C., T. C. Sauer Jr., D. O. Stuebner, and R. P. Meek. An Environmental Study to Assess the Effect of Drilling Fluids on Water Quality Parameters During High Rate, High Volume Discharges to the Ocean. Symp., Res. on Environ. Fate and Effects of Drilling Fluids and Cuttings, Lake Buena Vista, FL., 1980.

B. C. Research. Lethal and Sublethal Bioassays on Tailing from Nanisivik Mine Ore. Project 1552, Prog. Rep., Prepared for Strathcona Miner. Service, No. 3, 1975.

- B. C. Research. Literature Review and Mine Tailing Sampling at the Bottom of Buttle Lake. Prepared for Westmin Resour. Ltd., 1981.
- B.C. Ministry of Environment. Pollution Control Objectives for the Mining, Smelting, and Related Industries of British Columbia. 1979, 15 pp.
- Backen, H., and L. Karbe. Environmental Research Accompanying a Deepsea Mining Project in the Red Sea. Pres., Intermaritec '80, Hamburg. Int. Conf. on Mar. Sci. and Ocean Eng., Hamburg, GFR, 1980.
- Baillod, C. R. Storage and Disposal of Iron Ore Processing Wastewater. U.S. EPA, Office of Res. and Develop., EPA-660/2-74-018, 1974.
- Baker, D. H., Jr. and R. B. Bhappu. Specific Environmental Problems Associated With the Processing of Minerals. Annu. Mtg. AIME, San Francisco, CA., Feb. 21-24, 1972.
- Bakun, A. Coastal Upwelling Indices, West Coast of North America, 1946-1971. Tech. Rep. NMFS SSRF-671, NOAA, Seattle, 1973, 103 pp.
- Barnard, W. D., and T. D. Hand. Treatment of Contaminated Dredged Material. Tech. Rep. DS-78-14, U.S. Army Eng. Waterways Experiment Station, Vicksburg, MS., 1978.
- Barrett, G. W., and R. Rosenberg (eds.). Stress Effects on Natural Ecosystems. Wiley, 1981.
- Bascom, W. Coastal Water Research Project, Biennial Report for the Years 1981-1982. Southern California Coastal Water Res. Project, 1982.
- Bascom, W. Coastal Water Research Project Biennial Report for the Years 1979-1980. Southern California Coastal Water Res. Project, 1980.
- Bascom, W. A Regional Ocean Monitoring Plan. In Coastal Water Res. Project, Biennial Rep. 1981-1982, ed. by W. Bascom, 1982, pp. 39-44.
- Bascom, W. A Scale of Marine Contamination. Assimilative Capacity of the Oceans for Man's Wastes, Scop/ICSU Acad. Sinica, Taipei, Republ. of China,.
- Bascom, W., D. Young, and A. Mearns. How to Develop Rational Standards for Ocean Discharge of Metals. The Bull., v. 1, 1976, p. 74.
- Baseden, S. Environmental Study of the Disposal of Red Mud Waste. Mar. Pollut. Bull., v. 7, No.1, 1976, pp. 4-7.
- Beak. Pre-Operational Survey of Rupert Inlet. Rep. to Utah Constr. Min., 1971.
- Bechtel Civil & Minerals, Inc. Fjord Circulation and Tailings Transport Model Documentation Manual. 1985.
- Bell, L. M., and R. J. Kallman. The Kitman River Estuary, Status of Environmental Knowledge to 1976. Bibliography from Rep. of the Estuary Working Group, Dep. of the Environ. Spec. Estuary Series, West Vancouver, B.C., No. 6, 1976.
- Bella, D. A., and J. E. McCauley. Environmental Considerations for Estuarine Dredging Operations. Proc. World Dredging Conf., 1972, pp. 457-478.
- Bigham, G. N. Survey Report, Bathymetric Survey of Boca de Quadra Fjord, Southeast Alaska, U.S. Borax Quartz Hill Molybdenum Project. Rep. No. TC-3597, Tetra Tech., Inc., Bellevue, WA., 1982.
- Bigham, G., T. Ginn, A. M. Soldate, and L. McCrone. Evaluation of Ocean Disposal of Manganese Nodule Processing Waste and Environmental Considerations. Final Rep. TC-3514, Tetra Tech., Inc., Seattle, WA., Prepared for: Office of Ocean Min. & Energy & Criteria & Standards Div., EPA, 1982, 423 pp.

- Blackstock, J. and C. Filion-Myklebust. Environmental and Biochemical Investigation of Some Effects of Organic Pollution in Inner Oslofjore, Norway. *Mar. Biol.*, v. 73, 1983, pp. 155-163.
- Bondam, J. and G. Asmund. Environmental Studies in Quamarujuk and Agfardlikavska Fjords, Umanak District Central West Greenland. *Rapport Gronland Geologiske Undersogelse*, 1973.
- Bondam, J., and G. Asmund. Environmental Studies in the Quamarujukand Agfardlikavska Fjords, Umanak District, Central West Greenland. *Rapport Gronlands Geologiske Undersogelse*, No. 65, 1974, pp. 29-33.
- Brannon, J. M. Evaluation of Dredged Material Pollution Potential. WES-TR-DS-78-6, AD-A059-724, 1978.
- Brehmer, M. L. Turbidity and Siltation as Forms of Pollution. *J. Soil Water Cons.*, v. 20, No. 4, 1965, 132 pp.
- Brief of Alcan Smelters and Chemicals Ltd. Submission to the Public Inquiry into Pollution Control Objectives for the Mine,. Mine-Milling and Smelting Industry of B. C. Canada, 1977.
- Bright, D. A Synopsis of the Environmental Monitoring Program at Island Copper Mine, Rupert Inlet, B. C. Rep. to D. Ellis, Univ. Victoria, 1985, 22 pp. plus appendices.
- Brinkhurst, R. O., B. Burd, and R. D. Kathman. Benthic Studies in Alice Arm, B. C. During and Following Cessation of Marine Tailings Disposal, 1982 and 1986. *Can. Tech. Rep. Hydrog. Ocean Sci.*, v. 89, 1987, 45 pp.
- Brooks, E. A., J. J. Trefry, T. Sauer, C. Schwab, B. Bernard, J. Schofield, C. S. Giam, and E. R. Meyer. Environmental Aspects of Ocean Dumping in the Western Gulf of Mexico. *J. Water Pollut. Control Fed.*, v. 52, No. 2, 1980, pp. 329-350.
- Brothers, D. E. Marine Environmental Assessment of Tasu Sound, B. C., June, 1977. *Fish. and Environ., Can., EPS, Reg. Program Rep. 78-12*, 1978.
- Brown, B. E. Marine Pollution Research in South-East Asia. *Mar. Pollut. Bull.*, v. 16, No. 3, 1985, pp. 95-97.
- Brown, B. E. and M. C. Holley. Metal Levels Associated with Tin Dredging and Smelting and Their Effect Upon Intertidal Reef Flats at Ko Phuket, Thailand. *Coral Reefs*, v. 1, 1982, pp. 131-137.
- Brown, B. E., and M. C. Holley. The Influence of Tin Smelting and Tin Dredging on the Intertidal Reef Flats of Phuket, Thailand. Ch. in *The Reef and Man*, ed. by E. D. Gomez and C. E. Birkeland, *Proc. Int. Coral Reef Symp.*, 4th, v. 1, 1981, 214 pp.
- Brown, D. A., and B. E. Thompson. Using the Natural Detoxification Capacities of Organisms to Assess the Assimilative Capacity of the Environment. Ch. in *Aquat. Toxicol. and Hazard Assess.*, 7th Symp., ed. by R. D. Cardwell, R. Bahner and R. Purdy. ASTM,.
- Brown, D. A., M. E. McFarland, And K. A. Thompson. McMicking Point Pre-Discharge Monitoring of Sediments and Mussels. *Rep. Cap. Reg. Dist. B. C.*, 1980, 76 pp.
- Bruland, K. W., K. Bertine, M. Koide, and E. D. Goldberg. History of Metal Pollution in Southern California Coastal Zone. *Environ. Sci. Tech.*, v. 8, 1974, pp. 425-432.
- Bryan, G. W. Heavy Metal Contamination in the Sea. Ch. in *Mar. Pollut.*, ed. by R. Johnson, *Acad.*, 1976, pp. 185-302.
- Bryan, G. W. Recent Trends in Research on Heavy-Metal Contamination in the Sea. *Helgolander Meeresuntersuchungen*, v. 286, No. 1-4, 1980, pp. 6-25.
- Burks, S. A., and R. M. Engler. Water Quality Impacts of Aquatic Dredged Material Disposal (Laboratory Investigations). *Tech. Rep. DS-78-4*, U. S. Army Eng. Waterways Experiment Station, Vicksburg, MS., 1978.

- Burrell, D. C. Marine Environmental Studies in Boca de Quadra and Smeaton Bay: Physical and Chemical. Data Appendix V, Boca de Quadra: Dissolved Oxygen Distributions Through September, 1980. Inst. of Mar. Sci., Univ. of AK, 1981.
- Burrell, D. C. Marine Environmental Studies in Boca de Quadra and Smeaton Bay: Chemical and Geochemical, 1980. Inst. of Mar. Sci., Univ. of AK, Fairbanks, 1981.
- Burrell, D. C. Marine Environmental Studies in Boca de Quadra and Smeaton Bay: Physical and Chemical. Unpublished Interim Rep. for the Period Jan. - Apr. 1980 to U. S. Borax & Chem. Corp., Inst. Mar. Sci. Univ. AK, Fairbanks, 1980.
- Burrell, D. C. Marine Environmental Studies in Boca de Quadra and Smeaton Bay: Chemical and Geochemical, 1980. Rep. R82-2, Inst. Marine Sci., Univ. of AK., 1980.
- Burrell, D. C. Marine Environmental Studies in the Wilson Arm/Smeaton Bay System: Chemical and Geochemical, 1981. Inst. of Mar. Sci., Univ. of AK., Fairbanks, 1982.
- Burrell, D. C. The Biogeochemistry of Boca de Quadra and Smeaton Bay, Southeast Alaska. A Sum. Rep. on Investigations, 1980-1983, 1983.
- Burrell, D. C. Marine Environmental Studies in Boca de Quadra and Smeaton Bay: Physical and Chemical, Interim Summary Report for January-April, 1980. Inst. of Mar. Sci., Univ. of AK., 1980.
- Burrell, D. C. Marine Environmental Studies in Boca de Quadra and Smeaton Bay: Physical and Chemical Data Appendix VI: Nutrient Data October 1978 Through September 1980 (Acona 267 - Redoubt 011) for Boca de Quadra. Inst. of Mar. Sci., Univ. of AK., 1981.
- Burrell, D. C. The Pre-Impact Biogeochemical Environment of Boca de Quadra and Smeaton Bay Fjords, Southeast Alaska. Ch. in Mar. Tailings Disposal, ed. by D. V. Ellis, 1982, pp. 311-341.
- Burrell, D. C. and H. J. Niebauer. Marine Environmental Studies in Boca de Quadra: Physical and Chemical. Interim Rep., Inst. of Mar. Sci., Univ. of AK., Fairbanks, 1979, 64 pp.
- Burrell, D. C., H. J. Niebauer, and D. Nebert. Marine Environmental Studies in Boca de Quadra and Smeaton Bay: Physical and Chemical, 1979. Inst. of Mar. Sci., Univ. of AK., 1980.
- California Water Quality Control Board. An Investigation on the Fate of Organic and Inorganic Wastes Discharged into the Marine Environment and Their Effects on Biological Productivity. State of CA., State Water Qual. Control Board Publ. Prepared by Allan Hancock Foundation, Univ. of S. CA., No. 29, 1965.
- Cardinal, S. Canada's Fisheries Policy Called into Question by Amax's Dumping. Natl. Fishermen, 1981, p. 8.
- Cardwell, R. D., S. J. Olsen, M. I. Carr, and E. W. Sanborn. Biotic, Water Quality and Hydrologic Characteristics of Skyline Marina in 1978. Tech. Rep. 54, Dept. of Fish., State of WA., 1980.
- Carlson, K. T. The People's Lake. Environ., v. 17, No. 2, 1975, p. 16.
- Carter, L. Disposal of Wastes to Tidal Waters. Ch. in Min. and the Environ., ed. by M. S. Jones, Inst. Min. Metall., England, 1975, pp. 149-157.
- Casson, K. A., R. L. Cimberg, and C. H. Vock. Rocky Subtidal Zonation in Two Southeastern Alaskan Fjords. Abstr. of 63rd Annu. Mtg. of the Western Soc. of Naturalists, Long Beach, CA., 1982.
- Castilla, J. C. Environmental Impact in Sandy Beaches of Copper Mine Tailings at Chanaral, Chile. Mar. Pollut. Bull., v. 14, No. 12, 1983, pp 459-464.
- Castilla, J. C., and E. Nealler. Marine Environmental Impact due to Mining Activities of El Salvador Copper Mine, Chile. Mar. Pollut. Bull., v. 9, No. 3, 1978, pp. 67-70.

Champ, M. A. Ocean Waste Management: Policy and Strategies. An Int. Ocean Disposal Symp. Series, Spec. Symp., May 2-6, 1983.

Chamut, S. Battle of the Buttle or the Buttle Lake Situation. *Can. J. Public Health*, v. 60, 1969, pp. 169-172.

Chan, A. T. and G. C. Anderson. Environmental Investigation of the Effects of Deep-Sea Mining on Marine Phytoplankton and Primary Productivity in the Tropical Eastern North Pacific Ocean. *Mar. Min.*, v. 3, 1981, pp. 121-149.

Chansang, H., P. Boonyanate, and M. Charuchinda. Effect of Sedimentation from Coastal Mining on Coral Reefs on the Northwestern Coast of Phuket Island, Thailand. Paper in Proc. 4th Int. Coral Reef Symp., ed. by E. D. Gomez, C. E. Birkland, R. W. Buddemeir, R. E. Johannes, J. A. Marsh, and R. T. Rsuda, v. 1, 1981, pp. 129-136.

Chem. & Eng. News. Nontechnical Barriers Continue to Hold Back Deep-Ocean Mining. *V. 55, No. 49, 1977, p. 24.*

Chem. and Eng. News. Outlook for Marine Mining Clouded by Legal, Environmental, Other Problems. *V. 54, No. 46, 1976, pp. 30-31.*

Cimberg, R. L. Comparative Ecology of Mudflats in Southeast Alaska Fjords. *Abstr. Pac. Estuarine Res. Soc., Reg. Mtg., Western Washington State Univ., Bellingham, WA., Sep. 23-24, 1983.*

Cimberg, R. L. Abstract, Comparative Ecology of Mudflats in Southeast Alaska Fjords. .

Cimberg, R. L., K. A. Casson, and C. H. Vock. Rocky Intertidal Ecology of Two Southeastern Alaskan Fjords. *Abstr. of 63rd Annu. Mtg. of the Western Soc. of Naturalists, Long Beach, CA., 1982.*

Clark, M. J. R., and T. O. Morrison. Impact of the Westmin Resources Ltd. Mining Operation on Buttle Lake and the Campbell River Watershed. *Ministry of Environ., B. C., v. 1, 1982.*

Clark, M. J. R. A Preliminary Review of Buttle Lake Water Quality. Waste Management Branch, Ministry of Environ., Rep., Victoria, B. C., Appendices 1-4, No. 80-2, 1980, 32 pp.

Cleasby, J. V., Sir. F. Gibbard, J. W. Grimes, and Cuthbert. Environmental Aspects of Bouby Mine, Cleveland and Potash, Ltd., Yorkshire. Ch. in *Min. and the Environ.*, ed. by M. J. Jones, Inst. Min. & Metall., 1975, pp. 691-713.

Cole, R. A. Solid Wastes Pollution and Control. *J. Environ. Pollut. and Contam.*, v. 2, 1978.

Constantelos, B. G. Authorization to Proceed with Remedial Investigation/Feasibility Study (RI/FS) and Community Relations (CR) Activities at the Torch Lake Site. Houghton County, Michigan. Action Memo. U. S. Environ. Prot. Agency, 1988.

Cox, W. E. Law: Water Pollution Literature Review. *J. Water Pollut. Control Fed.*, v. 55, 1983, pp. 551.

Daily News. Local Crab Fishermen Sue AMAX. Prince Rupert, B. C., 1983.

Dalpra, C. Secondary Treatment Waivers Issued, Controversy Continues. *J. Water Pollut. Control Fed.*, v. 53, No. 11, 1981.

Dames & Moore. Commencement Bay Study, Summary and Synthesis. Dames & Moore For U. S. Army Corps. of Eng., Seattle Distr., Final Rep. 682-021-05, 1981.

Dames and Moore. Environmental Effects of Mine Tailings Discharged into the Coastal Zone Near Ite, Peru. Rep. to S. Peru Copper, 1986.

Davies, G. Red Sea Mine Tailings Must Go Deep. *Mar. Pollut. Bull.*, v. 16, No. 9, 1985, pp. 344-345.

Davis, F. T., D. E. Hyatt, and C. H. Cox. Environmental Problems of Flotation Reagents in Mineral Processing Plant Tailings Water. Ch. in Flotation, A. M. Gaudin Memorial V., ed. by M. C. Fuerstenau, Soc. Min. Eng. AIME, v. 2, 1976, pp. 130-141.

De Kock, W. C. and J. Kuiper. Possibilities for Marine Pollution Research at the Ecosystem Level. *Chemosphere*, v. 10, No. 6, 1981, pp. 575-603.

DeMill, D. Environmental Studies in Alice Arm and Hastings Arm, B. C., Part V. Initial Production Period -- Submersible Observations and Otter Trawls 1981-1982. EPS-PR-82-17, 1982.

DeMill, D. Environmental Studies in Alice Arm and Hastings Arm, Part V: Baseline and Initial Production Period - Amax/Kitsault Mine - Submersible Observations and Otter Trawls, 1980-1982. EPS-PR-83-05, EPA, 1983.

Department of Energy. Workshop on Copper in Estuarine, Continental and Marine Waters. CONF-771236 (Abstr.), Div. of Biomedical and Environ. Res., Washington, D. C., 1978.

Dethlefsen, V., and H. Rosenthal. Problems With Dumping of Red Mud in Shallow Waters, A Critical Review of Selected Literature. *Aquaculture*, v. 2, 1973, pp. 267-280.

Dewling, R. T. How Stringent Should Marine Waivers From Secondary Treatment Be. *J. Water Pollut. Control Fed.*, v. 58, No. 12, 1986, pp. 1101-1104.

Dexter, R. N., D. E. Anderson, E. A. Quinlan, L. S. Goldstein, R. M. Strickland, S. P. Pavlou, J. R. Clayton Jr., R. M. Kocan, and M. Landolt. A Summary of Knowledge of Puget Sound Related to Chemical Contaminants. NOAA Tech. Memo. OMPA-13, 1981.

Dollar, S. J., and R. W. Grigg. Impact of A Kaolin Clay Spill on a Coral Reef in Hawaii. *Mar. Biol. (W. Ger.)*, v. 65, 1981, 269 pp.

Donohue. Torch Lake Michigan Compository Summary. Donohue & Assoc.: Sheboygan, WI., 1988.

Dorcey, A. H., and B. R. Martin. Reaching Agreement in Impact Management: A Case Study of the Utah and Amax Mines. *Westwater Res. Cent.*, UBC, Vancouver, 1986, 29 pp.

Dorigan, J. Environmental Base Research, Marine Biochemical Studies. DOE/EV-0082, *Ecolog. Res. Div.*, Mar. Res. Program, H. M. McCammon, Director, U. S. Dep. of Energy, 1980, pp. 36.

Down, C. G., and J. Stocks. Environmental Problems of Tailings Disposal. *Min. Mag.*, v. 137, No. 1, 1977, pp. 25-33.

Down, C. G. and J. Stocks. The Environmental Problems of Tailings Disposal at Metal Mines. *Dep. of the Environ., Res. Rep.* 17, 1976, 33 pp.

Drinnan, R. W., and D. G. Bliss. The U.K. Experience on the Effects of Off-Shore Sand and Gravel Extraction on Coastal Erosion and the Fishing Industry. Dobrocky Seatech Ltd. for N.S. Dept. Mines Energy, 1986, 77 pp. plus appendices.

DuBois, C. Last Milepost: A Costly Environmental Struggle Nears Its Conclusion. *Barrons*, v. 11, 1977.

Duinker, J. C. Suspended Matter in Estuaries: Adsorption and Desorption Processes. Ch. in *Chem. and Biogeochem. of Estuaries*, ed. by E. Olausson and I. Cato. Wiley Intersci., 1980, pp. 121-150.

Duncan, D. W. Environmental Problems Associated with the Disposal of Mining and Milling Waste. *Western Miner.*, v. 45, No. 9, 1972, pp. 14-24.

Eade, A. Marine Mineral Development: An Integrated Approach to Industry and Environment. *Work Term Rep.*, 1990, 128 pp.

Eagle, R. A., P. A. Hardiman, M. G. Norton, R. S. Nunny, and M. S. Rolfe. The Field Assessment of Effects of Dumping Wastes at Sea. Ch. in *The Disposal of Solid Wastes Off the Northwest Coast of England* Fish. Res. Tech. Rep., v. 51, 1979.

Eccles, A. G. Pollution Control at Western Mines' Myra Falls Operations. *CIM*, v. 70, No. 785, 1977, pp. 141-147.

Elderfield, H., and A. Hepworth. Diagenesis, Metal and Pollution in Estuaries. *Mar. Pollut. Bull.*, v. 6, No. 6, 1975, pp. 85-87.

Ellis D. V. Case Histories in Environmental Science. *Mar. Pollut. Bull.*, v. 19, No. 12, 1988, pp. 656-661.

Ellis, D. V. Pollution Controls on Mine Discharges to the Sea. Paper in Proc. Int. Conf. on Heavy Metals in the Environ., Toronto, 1975, pp. 677-686.

Ellis, D. V. Environmental Audits. *Mar. Pollut. Bull.*, v. 16, No. 5, 1985, pp. 171-172.

Ellis, D. V. Environmental Consequences of Breaks and Interrupted Construction at Marine Outfalls in British Columbia. Proc. Conf. Inst. of Civil Eng., London, 1980.

Ellis, D. V. The Assessment and Control of Pollution in the Sea. Occasional Paper 32, Can. Comm. of UNESCO, Science in the Environment, 1978, pp. 3-9.

Ellis, D. V. A Decade of Environmental Impact Assessment at Marine and Coastal Mines. *Mar. Min.*, v. 6, 1987, pp. 385-417.

Ellis, D. V. Municipal and Other Marine Monitoring Programs in British Columbia. Rep. of Northwest Reg. Workshop on Ocean Pollut. Monitoring, Seattle, WA., 1981.

Ellis, D. V. Effectiveness of Existing Pollution Controls as Shown by Four Case Histories; and Recommendations for Future Control. Public Inquiry into Pollut. Contr. Objectives for the Min., Mine-Milling and Smelting Ind., Province of B. C., 1978.

Ellis, D. V. The Aquatic Resource Programme at Bougainville Copper Mine. Rep. Bougainville Copper Ltd., BCM Rep. RC 122, 1984, 121 pp.

Ellis, D. V. Problems in Metal Bioaccumulation Arising From Mining Industry Disposal of Tailings to the Sea. Proc. 11th Annu. Aquat. Toxicol. Workshop. Vancouver, B. C., Canada. Nov. 13-15, 1984.

Ellis, D. V. Taxonomic Sufficiency and Pollution Assessment. *Mar. Pollut. Bull.*, v. 15, No. 12, 1985, p. 459.

Ellis, D. V. Environmental Effects at the Jordan River Mine Outfall. Rep. to Jordan River Mines Ltd., 1973, 52 pp.

Ellis, D. V. Rehabilitation of the Marine Receiving Area at Jordan River Mine. Rep. to Pollut. Contr. Branch BC, 1975, 38 pp.

Ellis, D. V. *Environments at Risk; Case Histories of Impact Assessment*. Springer, 1989, 329 pp.

Ellis, D. V. Permitting and Regulating - Quartz Hill Molybdenum Mine (Alaska), Yabulu Nickel Refinery (Australia). Ch. 10 in *Environments at Risk; Case History of Impact Assessment*. Springer, 1989, pp. 242-269.

Ellis, D. V. Environmental Audits - Bougainville Copper Mine (Papua New Guinea). Ch. 9 in *Environments at Risk; Case Histories of Impact Assessment (Bibliography with Industry Reports Listed)*, 1989, pp. 225-241.

Ellis, D. V. Environmental Audits -- Marcopper Mining Corp. (The Philippines). Ch. 9 in *Environments at Risk*, ed. by D. V. Ellis. Springer, 1989, pp. 215-241.

Ellis, D. V. The Environmental Protection Program at the WestGold Marine Placer Mining Operation at Nome, Alaska, in the Context of Future Canadian Marine Placer Mining. Rep. to Ocean Mining Div. Ener. Min. and Res. Can., 1990.

Ellis, D. V. and C. Heim. Submersible Surveys of Benthos Near a Turbidity Cloud. *Mar. Pollut. Bull.*, V. 16, No. 5, 1985, pp. 197-203.

Ellis, D. V., and C. A. Pelletier. Long-term Considerations in Environmental Impact Assessment at a Coastal Mine Utilising Marine Tailings Disposal. *Rescan Rep. U.S. Borax*, 1982, 18 pp.

Ellis, D. V., and C. Heim. Submersible Surveys of Benthos Above the Tailings Turbidity Cloud in Rupert Inlet. *Univ. of Victoria Cruise Rep., Manuscript Rep., No. 244*, 1984.

Ellis, D. V., and J. D. Popham. Accidental Formation and Subsequent Disappearance of a Contaminated Beach. Ch. in *Sandy Beaches as Ecosyst.*, ed. by A. McLachlan and T. Erasmus, Junk, The Hague, 1983, pp. 719-726.

Ellis, D. V., and J. G. Goddard. Tailing Disposal to the Sea at Jordan River Mine: An Environmental Case-History From Pre-Discharge to Rehabilitation. *Manuscript*, 1975, 40 pp.

Ellis, D. V., C. A. Pelletier, and M. L. Wells. Long-Term Considerations in Environmental Impact Assessment for the Quartz Hill Submarine Tailing Disposal System. *Preliminary Draft. Rescan Environ. Services, Ltd.*, 1982.

Ellis, D. V., J. Littlepage, and W. Drinnan. The Macaulay Point Outfall Monitoring Program. *Annu. Rep. 1970-1971, Pre-Discharge Environ. and Biol. Data, Rep. to Capital Reg. Distr., Victoria*, 1971, 28 pp.

Ember, R. Reserve Mining; An Epic Battle Draws to a Close. *Environ. Sci. Tech.*, v. 11, No. 10, 1977, p. 948.

Engineer and Mining Journal. Reserve Case Takes New Twist as Governor Proposes Added Taconite Tax. V. 177, No. 12, 1976, 121 pp.

Engler, R. M. Impacts Associated With the Discharge of Dredged Material into Open Water. *EPA-600/3-78-084*, 1978, pp. 213-223.

Engler, R. M. The Regulation Guidelines and Criteria for the Discharge of Dredge Material: Prediction of Pollution Potential. *EPA 600/3-78-084*, 1978.

Engler, R. M. Prediction of Pollution Potential Through Geochemical and Biological Procedures: Development of Regulation Guidelines and Criteria for the Discharge of Dredged and Fill Material. Ch. in *Contam. and Sediments, Fate and Transport, Case Studies, Modeling, Toxicity*, ed. by R. A. Baker, *Ann Arbor Sci.*, v. 1, 1980, pp. 143-169.

Environmental Effects Laboratory. Ecological Evaluation of Proposed Discharge of Dredged or Fill Materials into Navigable Waters. *Misc. Paper D-76-17, U.S. Army Eng. Waterways Experiment Station, Vicksburg, MS.*, 1976.

Environmental Protection Agency. Development Document for Final Effluent Guidelines and New Source Performance Standards for the Ore Mining and Dressing Point Source Category. *Effluent Guidelines Division, Office of Water*, 1982, 656 pp.

Environmental Protection Agency/Corps of Engineers. Ecological Evaluation of Proposed Discharge of Dredged Material into Ocean Waters. *Environ. Effects Lab., U. S. Army Eng. Waterways Experiment Station, Vicksburg, MS.*, 1977.

Environmental Reporter. Firm to Pay \$1.84 Million to Filter Asbestos Tailings From Lake Superior. *Current Develop.*, 1751, 1982.

Environmental Systems & Service. Scoping Document for Quartz Hill Mine Development Environmental Impact Statement. Prepared for U. S. Forest Service, and U. S. Borax & Chem. Corp., 1983.

Environmental Systems & Service. Description of the Proposed Project and Alternative Concepts, Quartz Hill Mine Development, *Environmental Impact Statement Preliminary Draft, Appendix A*. 1983.

EPA 5th Annual Report. Ocean Dumping in the United States. 1977, 97 pp.

EPA 6th Annual Report. Ocean Dumping in the United States. 1977, 57 pp.

EPA Water Qual. Off. Proceedings, Conf. Pollut. Lake Superior Tributary Basin. 1971, pp. 14-15.

Erickson, L. J., and J. H. Deniseger. Impact Assessment of Acid Drainage From an Abandoned Copper Mine on Mt. Washington. Prepared by Waste Managem. Prog., Nanaimo, B. C. Publ. by Ministry of Environ. and Parks, 1987, 67 pp.

Evans, E., and C. Wong. Philippine Copper Mine Reopened. Financial Post, 1982.

Evans, J. B., D. V. Ellis, J. Leja, G. W. Poling, and C. A. Pelletier. Environmental Monitoring of Porphyry Copper Tailing Discharged into a Marine Environment. Paper in Proc. XIII Int. Miner. Processing Congr., Warsaw Poland, 1979, pp. 650-690.

Fallis, B. W. Trace Metals in Sediments and Biota From Strathcona Sound, NWT, Nanisivik Marine Monitoring Programme, 1974-1979. Can. Tech. Rep. of Fish. and Aquat. Sci., Western Reg., Dep. of Fish. and Oceans, Winnipeg, Manitoba, R3T 2N6, No. 1082, 1982, pp. 34.

Farrell, W. E. Long Reserve Mining Dispute is Far From Resolved. New York Times, 1976, p. 13.

Flint, R. W. Ecosystem Integration and Environment Decision Making. Coastal Ocean Pollut. Assess. News, Man and the Mar. Environ., v. 3, 1984, pp. 17.

Food and Agriculture Organization of the United Nations. Pollutants in the Aquatic Environment: Detection, Measurement and Monitoring. Lectures Pres. at the Second FAO/SIDA Training Course on Mar. Pollut. in Relation to Protection of Living Resour., 1976.

Forstner, U. Sources and Sediment Associations of Heavy Metals in Polluted Coastal Regions. Phys. Chem. Earth, v. 11, 1979, pp. 849-866.

Forstner, U. Inorganic Pollutants, Particularly Heavy Metals in Estuaries. Ch. in Chem. and Biogeochem. of Estuaries, ed. by E. Olausson and I. Cato. Wiley-Intersci., 1980, pp. 307-348.

Forstner, U., and G. T. Wittman. Metal Pollution in The Aquatic Environment. Springer, 1979.

Fyn, L. The Disposal of Waste from Mining of Titanium Concentrate: A Case Study of a Conflict Between Fisheries and Industry. Program and Abstr.; Third Int. Ocean Disposal Symp., Woods Hole Oceanogr. Inst., Woods, Hole, MA., 1981, pp. 122.

Gambrell, R. P., C. N. Reddy, and R. A. Khalid. Characterization of Trace and Toxic Materials in Sediments of a Lake Being Restored. J. Water Pollut. Control Fed., v. 55, 1983, pp. 1201.

Gibson, V., and G. Grice. A Compromise Between a Beaker and a Bay: The Big Bag. Oceans, v. 13, 1980, pp. 21-25.

Gideiri, Y. B. A. Impacts of Mining on Central Red Sea Environment. Deep Sea Res., v. 31, 1984, pp. 823-828.

Goddard, J. M. Oceanographic and Marine Biological Surveys in Alice Arm and Hastings Arm, B. C. Data Rep. to Dr. J. L. Littlepage. Dobracky Seatech Ltd., 1975, 41 pp.

Goldberg, E. D. The Oceans as Waste Space: The Argument. Oceanus, v. 24, 1981, pp. 2-9.

Goldberg, E. D. Assimilative Capacity of U. S. Coastal Waters for Pollutants. Proc. of a Workshop, Crystal Mountain, Washington, Jul. 29 - Aug. 4, 1979.

Goldberg, E. D. Marine Pollution. Ch. 17 in Chem. Oceanogr., ed. by J. P. Riley, and R. Chester, Acad., v. 3, 1975.

Golden, P. C. Monitoring Ocean Disposal Sites. Proc. 10th Annu. Conf. Mar. Technol. Soc., 1974, pp. 107-113.

Golder Associates. 1982 Proposed Work Plan for the Mine and Environmental Geohydrology Studies, Quartz Hill Project. 1982.

- Gonor, J. J., and P. F. Kemp. Procedures for Quantitative Ecological Assessments in Intertidal Environments. EPA-600/3-78-087, 1978.
- Gov. Can. Res. Metal Mining Liquid Effluent Regulations and Guidelines. EPS-1WP-77-1, 1977.
- Goyette, D. and H. Nelson. Marine Environmental Assessment of Mine Waste Disposal into Rupert Inlet, British Columbia. Surveillance Rep. EPS PR-77-11, Environ. Prot. Service, Pac. Reg., Environ. Canada, 1977.
- Goyette, D. E. Marine Tailings Disposal - Case Studies. Min. Effluent Regulations/Guidelines and Effluent Treatment Seminar, Banff, Alberta, Dec. 9-10, 1975.
- Goyette, D., and P. Christie. Environmental Studies in Alice Arm and Hastings Arm, British Columbia. Part III: Initial Production Period - AMAX/Kitsault Mine - Sediment and Tissue Trace Metals, May-June and October 1981. Reg. Program Rep. 82-14. Environ. Prot. Service, Environ. Canada. Pac. Reg. West Vancouver, B. C., 1982.
- Goyette, D., and P. Christie. Environmental Studies in Alice Arm and Hastings Arm, British Columbia. Part I: Baseline Studies AMAX/Kitsault Mine - Sediment and Tissue Trace Metals From Two Abandoned Mine Sites - B. C. Molybdenum and Anyox, 1976 - 1980. Environ. Prot. Service, Environ. Canada. Pac. Reg. Program Rep. 82-13, 1982, 141 pp.
- Grace, R. A. Sea Outfalls - A Review of Failure, Damage, and Impairment Mechanisms. Discussion. Proc. Inst. Civ. Eng., Part I, v. 80, 1986, pp. 553-557.
- Green, D. W. Life vs. Livelihood-Lake Superior Illustrates the Epic Struggle Between Environmental and Economic Values. New York Times Mag., 1974, pp. 16.
- Hamilton, E. I. (ed.). Cu and Cd Associated With Suspended Particulate Matter in Torres Strait. Mar. Pollut. Bull., v. 21, No. 10, 1990, pp. 484-486.
- Hamilton, R., and W. W. Fraser. A Case History of Natural Underwater Revegetation: Mandy Mine High Sulphide Tailings. Reclamation Rev., v. 1, No. 2, 1978, pp. 61-65.
- Harding, L., and M. Thomas. Baseline Sediment and Tissue Trace Metals in Barkley Sound, Quatsino Sound, Surf Inlet and Laredo Sound, British Columbia. Environ. Can. Reg. Prog. Rep., v. 87, No. 6, 1987, 137 pp.
- Harman, R. A., and J. C. Serwold. Aquatic Disposal Field Investigations, Duwamish Waterway Disposal Site, Puget Sound, Washington. Appendix F. Recolonization of Benthic Macrofauna Over a Deep-Water Disposal Site. Army Eng. Waterways Experiment Station Vicksburg, MS. Tech. Rep. D-77-24-APP-F, 1978.
- Harrison, F. L. A Review of the Impact of Copper Released Into Marine and Estuarine Environments. Tech. Rep. NUREG/CR-2823, UCRL-53042. Lawrence Livermore Natl. Lab., Livermore, CA., 1982.
- Hatfield, C. T., and G. L. Williams. A Summary of Possible Environmental Effects of Disposing Mine Tailings into Strathcona Sound, Baffin Island. ALUR 75-76-38, Dep. Indian Affairs Northern Develop. Canada, 1976.
- Haug, A., S. Melsom, and S. Omang. Estimation of Heavy Metal Pollution in Two Norwegian Fjord Areas by Analysis of the Brown Algae *Ascophyllum Nodosum*. Environ. Pollut., v. 7, 1980, pp. 179-192.
- Hawley, J. R. The Use Characteristics and Toxicity of Mine-mill Reagents in the Province of Ontario. Ontario Ministry of the Environ., 1972.
- Head, P. C., and J. D. Burton. Molybdenum in Some Ocean and Estuarine Waters. J. Mar. Biol. Assoc. UK., v. 50, 1970, pp. 439-448.
- Heggie, D. T. Copper in Sub-Arctic Waters of the Pacific Northwest. Ch. in Trace Metals in Seawater, ed. by C. S. Wong, et al, NATO Sci. Affairs Div., Plenum, 1983, pp. 97-112.
- Hershelman, G. P., P. Szalay, and C. Ward. Metals in Surface Sediments From Point Dume to Point Hueneme. Ch. in Coastal Water Res. Project, Biennial Rep. 1981-1982, ed. by W. Bascom, 1982, pp. 259-265.

- Hervey, W. R. Environmental Monitoring Programs during 1983, Quartz Hill Molybdenum Project, Southeast Alaska. 1984.
- Hervey, W. R. Environmental Monitoring Programs At Quartz Hill Alaska during 1982. 1983.
- Hervey, W. R. Environmental Monitoring Programs at Quartz Hill, Alaska during 1981. 1982.
- Hildebrand, L. P. An Assessment of Environmental Quality in the Baie des Chaleurs. Environ. Can. EPS-5-AR-84-8, 1984, 191 pp.
- Hirsch, A. The Impact of Ocean Pollution. EPA J., v. 7, No. 3, 1981, pp. 16-19.
- Hogarty, B. J. The Fate of Molybdenum and Other Heavy Metals in Two Southeast Alaska Fjords.. PhD Thesis, 1985.
- Holton, R. L., N. H. Cutshall, L. I. Gordon, and L. F. Small. Aquatic Disposal Field Investigations, Columbia River Disposal Site, Oregon. Appendix B. Water Column, Primary Productivity, and Sediment Studies. OR. State Univ. Corvallis School of Oceanogr., WES-TR-D-77-30-APP-B, 1978.
- Hood, D. W., V. Fisher, and D. Nebert. Study of the Marine Environment Near Nome, Alaska. Environ. Inst. of Mar. Sci., Inst. of Social, Econ. and Gov. Res., Univ. of AK., Fairbanks, 1974.
- Horne, R. A. Marine Chemistry: The Structure of Water and the Chemistry of the Hydrosphere. Ch. in The Sea-Ocean Bottom Interface, Wiley, 1969, pp. 239-291.
- Hoskin, C. M. Macrobenthos From Three Fjords in Western Prince William Sound, Alaska. IMS Rep. 77-1, Inst. of Mar. Sci., Univ. of AK., Fairbanks, 1977.
- Howell, B. R., and R. G. J. Shelton. The Effect of China Clay on the Sediments of St. Austell and Mevagissey Bays. J. Mar. Biol. Assoc. U.K., v. 50, No. 3, 1970, pp. 593-607.
- Howell, B. R., R. G. J. Shelton. The Effect of China Clay on the Bottom Fauna of St. Austell and Mevagissey Bays. J. Mar. Biol. Assoc. U.K., v. 50, 1970, pp. 593-607.
- Hueck-van der Plas., E. H. (ed.). Disposal of Chemical Waste in the Marine Environment. Implications of the International Dumping Conventions. Chemosphere, v. 10, 1981, pp. 507.
- Huyck, L. M., and J. P. Reganold. Environmental Policies and Issues Surrounding Holden Mine Tailings: A Case Study of an Orphaned Mine. Ch. in Environ. Impact Assess. Rev., Elsevier, v. 9, No. 2, 1989, pp. 97-123.
- ICM. Land Tailing Environmental Impact Assessment Island Copper Mine. Utah Mines Ltd., 1976, 196 pp. plus appendices.
- Ind. Res. Dev. Briny Deep May Solve Toxic Storage Problems. V. 21, No. 10, 1979, pp. 35-36.
- Inoue, Y. Comparative Study of the Safety of Sea Disposal and Land Disposal of Low and Intermediate Level Radioactive Solid Wastes, (1). Rad. Res., v. 20, No. 1, 1979, pp. 53.
- Island Copper Mine. 1978 Annual Environmental Assessment Report. Utah Mines Ltd., 1979.
- Island Copper Mine. 1980 Annual Assessment Report. Utah Mines Ltd., v. 1, 1982.
- Island Copper Mine. Annual Environmental Assessment Report. 1984.
- Island Copper Mine. Annual Environmental Assessment Report. 1985.
- Island Copper Mine. Annual Environmental Assessment Report. Utah Mines Ltd. 2 Vols., 1986.
- Island Copper Mine. Reclamation Report for 1985. Utah Mines Ltd., 1986, 31 pp.

- Island Copper Mine. Annual Environment Assessment Report. Utah Mines Ltd., 2 Vols, 1987.
- Island Copper Mine. . Annual Environmental Assessment Report, 2 Vols, 1985.
- Island Copper Mine. 1983 Annual Environmental Assessment Report. Utah Mines Ltd., 2 Vols, 1984.
- Island Copper Mine. 1982 Annual Environmental Assessment Report. Utah Mine Ltd., 2 Vols, 1983.
- Issacs, J. D. Assessment of Man's Impact in Marine Biological Resources. Ch. in Mar. Pollut. and Mar. Waste Disposal, ed. by E. Pearson, and E. D. Frangipane, Pergamon, 1975, pp. 329-349.
- Iwamoto, R., E. Salo, M. Madej, and R. McComas. Sediment and Water Quality: A Review of the Literature Including a Suggested Approach for Water Quality Criteria. U. S. Environ. Prot. Agency Rep. EPA 910/9-78-048, 1978.
- Jeffery, J. An Assessment of Proposed Tailings Disposal Options on the Quality of Jaba River Water and Empress Augusta Bay Seawater. BCM Rep. RB 178, 1983.
- Jones & Stokes Associates, Inc. Ocean Discharge Criteria Evaluation, Quartz Hill Mill Tailings Disposal. 1985.
- Jones & Stokes Associates, Inc. Ocean Discharge Criteria Evaluation: Quartz Hill Mine Tailings Disposal in Boca de Quadra. U.S. EPA Reg. 10. Prelim. Draft, 1984.
- Jones, A. A. The Role of Biologists in Pollution Control Branch Decision Making, With Particular Reference to the Ganges Harbour and Utah Mines Cases. MPA Thesis, Univ. Victoria, 1975.
- Kaiser Engineers, Inc. An Environmental Overview of the Quartz Hill Molybdenum Project. Oakland, CA., 1980.
- Karbe, L., H. Thiel, H. Weikert, and A. J. B. Mill. Environmental Impact Study. Mining of Metalliferous Sediments From the Atlantis II Deep. Pre-mining Environmental Conditions and Risk to the Environment. 1981.
- Kay, B. H. Pollutants in British Columbia's Marine Environment; A Status Report. SOE Rep. No. 89-1. Minister of Supply and Services Canada, Catalogue No. EN 40-209/89-1E, 1989.
- Kay, B. H. A State of the Environment Fact Sheet: Pollutants in British Columbia's Marine Environment. SOE Fact Sheet No. 89-2, Minister of Supply and Services Canada, Catalogue No. EN1-12/89-2E, 1989, 12 pp.
- Kemper, B., S. Stephansson, and R. Schweinsburg. Environmental Baseline Studies, 1975 Strathcona Sound Program. Prelim. Rep., Environ., 1976.
- Kendall, K. K. Composition of 1976 Environmental Water Samples from Quartz Hill, Alaska. 1977, 42 pp.
- Ker, W. A. Water Resources of the Mining Industry in British Columbia. West. Miner., v. 47, No. 12, 1974, pp. 33.
- Kester, D. R. The Ocean as a Dump Site: Studies Basic to a National Policy. Maritimes, v. 22, No. 2, 1978, pp. 10-11.
- Ketchikan Daily News. Amax Mine Will be Meet Topic. Ketchikan Daily News, 1981.
- Kevis, D. A Native of the Inlet System Remarks on Utah Waste Report. North Island Gazette, 1981.
- Kimball III, D. P., and D. L. Moellenberg. An Industry View of the Regulation of Mining Waste and Other Solid Waste Under Subtitle D of the Resource Conservation and Recovery Act. From Gallagher & P. A. Kennedy, Phoenix, AZ., 17 pp.
- Klien, D. H., and E. D. Goldberg. Mercury in the Marine Environment. Environ. Sci. Technol., v. 4, 1970, pp. 765-768.
- Knauer, G. A. Immediate Industrial Effects on Sediment Metals in a Clean Coastal Environment. Mar. Pollut. Bull., v. 8, No. 11, 1977, pp. 249-254.

Knauer, G. A. Immediate Industrial Effects on Sediment Mercury Concentrations in a Clean Coastal Environment. *Mar. Poll. Bull.*, v. 7, No. 6, 1976, pp. 112-115.

Knauss, A. The Role of the Ocean in a Waste Management Strategy, A Special Report to the President and the Congress. *Natl. Advisory Com. on Oceans and Atmos.*, 1981.

Kocan, R. M., K. M. Sabo, and M. L. Landolt. Cytotoxicity/Genotoxicity: The Application of Cell Culture Techniques to the Measurement of Marine Sediment Pollution. *Aquat. Toxicol.*, v. 6, 1985, pp. 165-177.

Kolesnikov, A. A., L. V. Chernykh, and N. P. Baturin. Effect of the Chadak Tailings Dump on the Contamination of the Chadak River Water. *Sb. Tr. N.-I. I. Proket In-t po Obogashch. Rud. Tsvet. Met., Kazmekhanobr*, 78, v. 78, No. 20, 1978, pp. 132-135.

Konasewich, D. E., P. M. Chapman, E. Gerencher, G. Vigers, and N. Treloar. Effects, Pathways, Processes, and Transformation of Puget Sound Contaminants of Concern. *NOAA Tech. Memo. OMPA-20*, 1982.

Krauss, R. E. Environmental Management at Homestake's McLaughlin Mine. *Soc. for Min., Metall., and Expl.*, Littleton, CO. Preprint No. 90-23, 1990, p. 12.

Kuehnert, M. Several Questions on Environmental Pollution and Toxicological Assessment of Residues of Heavy Metals (Mercury, Lead, Cadmium). *Arch. Exp. Veterinaarmed*, 93:180263q, v. 34, No. 3, 1980, pp. 339-345.

Leddy, D. G. Torch Lake Study. Project Completion Rep. Prepared for the Michigan Dep. of Natur. Resour. Michigan Technol. Univ., 1986.

Leduc, G., H. Ruber, and M. Webb. Toxicity Studies in Relation to Mining in the Northwest Territories. *ALUR 73-74-34*, Dep. of Indian Affairs and Northern Develop., 1974.

Lee, C. S. and K. Y. Chen. Migration of Trace Metals in Interfaces of Seawater and Polluted Surficial Sediments. *Environ. Sci. and Tech.*, v. 11, 1977, pp. 174-182.

Lee, G. Summary of Studies on the Release of Contaminants From Dredge Sediments on Openwater Disposal. *Proc. Int. Symp., Sep. 6-10, 1976, Interactions Between Sediments and Freshwater*, ed. by H. L. Goltermand, Junk B. V., Pub. The Hague, 1977.

Lee, G. F. Role of Hydrous Metal Oxides in the Transport of Heavy Metals in the Environment. *Heavy Metals in the Aquat. Environ., Proc. of the Int. Conf. held in Nashville, TN. Pergamon*, 1973, pp. 137-147.

Lee, G. F., and G. M. Mariani. Evaluation of the Significance of Waterway Sediment-Associated Contaminants on Water Quality at the Dredged Material Disposal Site. *Ch. in Aquat. Toxicol. and Hazard Eval., ASTM STP 634*, ed. by F. L. Mayer, and J. L. Hamelink, 1977, pp. 196-213.

Lee, G. F., and G. R. Lanza. Significance of Sediment Associated Contaminants in Water Quality Evaluation. *Occasional Paper No. 11, Cent. for Environ. Studies, Univ. of TX., Dallas*, 1978.

Lee, G. F., J. M. Lopez, and G. M. Mariani. Leaching and Bioassay Studies on the Significance of Heavy Metals in Dredged Sediments. *Ch. in Proc. Int. Conf. on Heavy Metals in the Environ., Toronto*, 1975, pp. 731-764.

Lesaca, R. M. Marine Pollution and Research in the Philippines. *Ch. in Mar. Pollut. & Sea Life*, ed. by M. Ruivo, *FAO-UNIPUB*, 1973, 82 pp.

Levings, C. D., and N. G. McDaniel. Industrial Disruption of Invertebrate Communities on Beaches in Howe Sound. *B. C. Fish. and Mar. Sci., Environ. Canada, Tech. Rep., No. 663*, 1976.

Levings, C. D., and N. G. McDaniel. Data Report on Effects of Dissolved Oxygen Deficiency in Bottom Waters of Howe Sound: Trawl Data January 1978 to March 1979 and Oceanographic Data August 1977 to March 1979. *Can. Data Rep. Fish. and Aquat. Sci., No. 217*, 1980.

- Lewis, J. R. Problems and Approaches to Baseline Studies in Coastal Communities. Ch. in *Mar. Pollut. and Sea Life*, ed. by M. Ruivo, Fishing News (Books) Ltd. Surv., England, 1972, pp. 401-404.
- Lewis, M. A. and V. T. Wee. Aquatic Safety Assessment for Cationic Surfactants. *Environ. Toxicol. Chem.*, v. 2, 1983, pp. 105-118.
- Lind, A. E., and G. E. Glass. Asbestos Contamination of Lake Superior: Ten Years of Litigation -- U. S. A. vs Reserve Mining Company. Ch. in *Contam. and Sediments*, ed. by R. A. Baker, Ann Arbor Sci., 1980, pp. 219-270.
- Liss, R. G., F. Knox, D. Wayne, and T. R. Gilbert. Availability of Trace elements in Drilling Fluids to the Marine Environment. *Symp.: Res. on Environ. Fate and Effects of Drilling Fluids and Cuttings, Lake Buena Vista, FL.*, Jan. 21-24, 1980.
- Long, E. R. An Assessment of Marine Pollution in Puget Sound. *Mar. Pollut. Bull.*, v. 13, No. 11, 1982, pp. 380-383.
- Loring, D. H., and G. Asmund. Heavy Metal Contamination of a Greenland Fjord System by Mine Wastes. *Environ. Geol. and Water Sci.*, v. 14, No. 1, 1989, pp. 61-71.
- Lucas, A. R., and P. A. Moore. The Utah Controversy: A Case Study of Public Participation in Pollution Control. *Natur. Res. J.*, v. 13, No. 1, 1973, pp. 36-75.
- Ludwig, H. F. Environmental Guidelines for Coastal Zone Management in Thailand, Zone of Phuket. *Natl. Environ. Board, Thailand*, 1976, 101 pp.
- MacDonald, R. W. Proceedings of a Workshop on the Kitimat Marine Environment. *Can. Tech. Rep. Hydrog. Ocean Sci.*, No. 18, 1983.
- MacDonald, R. W., et al. Workshop on the Kitimat Marine Environment. *Abstr., Inst. of Ocean Sci., Sidney, B.C.*, 1980.
- Malins, D. C. Pollution of the Marine Environment. *Environ. Sci. Tech.*, v. 14, No. 1, 1980, pp. 32-37.
- Marine Ecosystems Analysis Program Office. Progress Report, Deep Ocean Mining Environmental Study-Phase I. NOAA Tech. Memo. ERL MISA-15, NOAA Environ. Res. Lab., Boulder CO., 1976.
- Marine Pollution Bulletin. Pacific Mine Waste Dumping Causes Furor. v. 12, No. 7, 1981, 228 pp.
- Martin, B. R. The Causes of Scientific Disputes in Impact Assessment and Management: The Utah Mines Case. MSc Thesis, Univ. B. C., 1985.
- Mayer, G. F. Ecological Stress and the New York Bight: Science and Management. *Estuarine Res. Federation, Columbia, SC.*, 1982.
- McAllister, D. E. Mine Pollution at Marinduque Island in the Philippines. *Sea Wind*, v. 1, No. 3, 1987, pp. 26-27.
- McCammon, H. M. Ecological Research Division, Marine Research Program. DOE/EV-0082, U.S. Dep. of Energy, 1980.
- McElroy, R. O., and A. R. Bohn. Possible Environmental Effects of Disposing Mine Tailings into Strathcona Sound, Baffin Island. Draft Rep., Project 1552, Prog. Rep., Prepared for Strathcona Miner. Serv. Ltd., No. 4, 1975.
- MDNR. Remedial Action Plan for Torch Lake Area of Concern. Michigan Dep. of Natur. Resour., Surface Water Quality Div. Lansing, MI., 1987.
- Menzie, C. A. Diminishment of Recruitment: A Hypothesis Concerning Impact on Benthic Communities. *Mar. Pollut. Bull.*, v. 15, 1984, pp. 127-128.
- Merefield, J. R. Ten Years of Barium Build-up in the Teign. *Mar. Pollut. Bull.*, v. 18, No. 5, 1987, pp. 220-222.

- Mikkelsen, E. Looking Over the Black Angel's Shoulder. *Can. Min. J.*, v. 8, 1974, pp. 30-36.
- Minerals Management Service. Draft Environmental Impact Assessment: Proposed Outer Continental Shelf Polymetallic Sulfide Mineral Lease Offering Gorda Ridge Area. 1983, 580 pp.
- Minerals Management Service. OCS Mining Program Norton Sound Lease Sale: Draft Environmental Impact Statement. Prepared by AK. OCS Reg. (OCS EIS/EA, MMS 88-0082), 1988, 231 pp.
- Mining Journal. Reserve Wins a Round. V. 288, No. 7392, 1977, p. 310.
- Mitchell, J. G. Corporate Responsibility in Silver Bay. *Audubon*, v. 77, No. 2, 1975, pp. 46.
- Moore, J. N., and S. N. Luoma. Hazardous Wastes From Large Scale Metal Extraction: A Case Study. Ch. in *Environ. Sci. and Technol.*, Am. Chem. Soc., Washington, D.C., v. 24, No. 9, 1990, pp. 1278-1285.
- Moore, P. Slow, Sure Death Faces Rupert Inlet. *North Island Gazette*, 1975.
- Moore, P. Island Copper Mine as an Example of the Impact of Technology on the Environment. Ph.D. Appl. Sci. UBC.
- Mottet, M. G. Enhancement of the Marine Environment for Fisheries and Aquaculture in Japan. Ch. 5 in *Artificial Reefs, Marine and Fresh Water Applications*, ed. by F. M. D'Itri, Lewis, 1985, pp. 13-112.
- Mustafa, Z., and H. Amann. Ocean Mining and Projection of the Marine Environment in the Red Sea. OTC 3188, *Proc. Annu. Offshore Technol. Conf.*, 9th, 1978.
- National Oceanic and Atmospheric Administration (NOAA). Report to the Congress on Ocean Dumping Monitoring and Research, January - December 1978. 1980, 42 pp.
- Nawab, Z. A., and Y. A. Gideiri. Tailing Disposal and Red Sea Environment. *Oceanexpo Middle East*, Bahrain, Feb. 13-18, 1982, 1982, 5 pp.
- Nebert, D. L. and D. C. Burrell. *Marine Environmental Studies in Boca de Quadra and Smeaton Bay: Physical Oceanography*, 1980. Inst. of Mar. Sci. Univ. of AK, 1981.
- Nebert, D. L. and D. C. Burrell. *Marine Environmental Studies in Boca de Quadra and Smeaton Bay: Physical Oceanography*, 1980. Rev. by 1982, Inst. of Mar. Sci. Univ. of AK, 1982.
- New York Times. Reserve Mining Ends Dumping in Lake. V. 16, 1980.
- Nollkaemper, A. Laws of the Sea: Development of Regulations for Protecting the Marine Environment From Deep-sea-bed Mining. *Mar. Pollut. Bull.*, v. 21, No. 11, 1990, pp. 503-505.
- O'Halloran, R. L. Ocean Dumping: Progress Toward a Rational Policy of Dredged Waste Disposal. *Environ. Law*, v. 12, 1982, pp. 745.
- Okubo, A., C. C. Ebbesmeyer, J. W. Helseth, and A. S. Robbins. Reanalysis of the Great Lakes Drogue Studies Data. Special Rep. 2, Refer. 76-2, *Mar. Sci. Res. Cent.*, State Univ. of NY., 1976.
- Olausson, E. Man-Made Effect on Sediments from Kattegat and Skagerrak. *Geolog., Foeren. Stockholm Foerhand*, 1975, 97 pp.
- Osterberg, C. Dump Wastes in the Vast Oceans. *Seattle PI From New York Times*, 1981.
- Oviatt, C. A., M. E. Pilson, et al. Recovery of a Polluted Estuarine System: A Mesocosm Experiment. *Mar. Ecol. Prog. Ser.*, v. 16, No. 3, 1984, pp. 203-217.
- Owen, R. M. An Assessment of the Environmental Impact of Mining on the Continental Shelf. *Mar. Min.*, v. 1, No. 1/2, 1977, pp. 85-102.

- Ozturgut E., J. W. Lavelle, O. Steffin, and S. A. Swift. Environmental Investigations During Manganese Nodule Mining Tests in the North Equatorial Pacific in November 1978. U.S. Natl. Ocean Atmos. Admin. Tech. Mem. ERL MESA-48, 1980, 50 pp.
- Packman, G. A., and R. G. Shearer. Overview of Marine Environmental Quality in the Canadian Arctic. Ch. in Can. Conf. on Mar. Environ. Quality: Proc., Feb. 29-Mar. 3, Halifax, Nova Scotia. The Int. Inst. for Transportation and Ocean Policy Studies, 1988, pp. 229-242.
- Parson, T. R., J. W. Murray, R. D. Marshall, and C. Bawden. Review of the Environmental Status of Rupert Inlet, B. C. Rep. to ICM, 1977.
- Parsons, T. R. Pollution Problems in the Strait of Georgia. Ch. in Mar. Pollut. and Sea Life, ed. by M. Ruivo, Fishing News (Books) Ltd., England, 1973, pp. 72-77.
- Parsons, T. R., J. W. Murray, R. D. Macdonald, and V. I. Macdonald. Review of the Environmental Status of Rupert Inlet, B. C. Rep. to ICM, 1979.
- Patchett, M. A., and J. E. Dent. Development of a National Policy for Water Quality Monitoring in Papua New Guinea. Water Quality Bull., v. 10, No. 3., pp. 126-131.
- Paulsen, J.C. Quartz Hill Molybdenum Project, Southeast Alaska. An Environmental Update. 1985.
- Pearson, E. A., Editor. Proc. of the First Int. Conf. on Waste in the Mar. Environ., 1959 Pergamon, 1960, 569 pp.
- Pearson, E. A., and E. D. Frangipane. Marine Pollution and Marine Waste Disposal. Proc. 2nd, Int. Cong. San Remo, Italy, Dec. 17-21, 1973.
- Pedco Environmental, Inc. Study of Adverse Effects of Solid Wastes from All Mining Activities in the Environment. USEPA, Island Extract Processes Div., Contract No. 68-01-4700, 1979.
- Pedersen, F. B. The Sensitivity of Baltic Sea to Natural and Man-Made Impact. Ch. in Hydrodyn. of Semi-Enclosed Seas, ed. by J. Nihoul, and C. J. Elsevier Sci., 1982.
- Pelletier, C. A. Environmental Data Handling and Long-term Trend Monitoring at Island Copper Mine. Ch. in Mar. Tailings Disposal, ed. by D. V. Ellis, Ann Arbor Sci., 1982, pp. 197-238.
- Pelletier, C. A., and R. J. Hillis. Reclamation at Island Copper. Ch. in Reclamation of Lands disturbed by Mining BC Ministry Mines Pet. Res., 1977, pp. 55-64.
- Pelletier, C. A., G. W. Poling, and D. V. Ellis. Comparative Environmental Assessment of Tailings Disposal Alternatives, Canadian Experience with Submarine Tailings Disposal. Prepared for Bechtel Civil & Min. Inc., 1983.
- Pelletier, C. A., G. W. Poling, and D. V. Ellis. Canadian Experience With Submarine Tailings Disposal App. E. in Rescan Comparative Environmental Assessment of Tailings Disposal Alternatives. Rep. to Bechtel civil and Minerals Inc. CA., 1983.
- Peter, G., and T. O'Connor. Ocean Disposal and Monitoring. Ch. in Waste Disposal in the Oceans, Minimizing Impact, Maximizing Benefits, ed. by D. F. Soule, and D. Walsh, Westview, 1983.
- Petr, T. Possible Environmental Impact on Inland Waters of Two Planned Major Engineering Projects in Papua, New Guinea. Environ. Conserv., v. 6, No. 4, 1979, pp. 281-286.
- Petrazzulo, G. An Environmental Assessment of Drilling Fluids and Cuttings Released onto the Outer Continental Shelf for the Gulf of Mexico. Ocean Programs Branch Office of Water and Waste Management, v. 1, 1981.
- Plumb, R. H., Jr. Potential Effects of the Discharge of Taconite Tailings on Water Quality in Lake Superior. Diss. Abstr. Int. Bull., v. 34, No. 10, 1974, p. 5253.

Plumb, R. H., Jr.. A Study of the Potential Effects of the Discharge of Taconite Tailings on Water Quality in Lake Superior. Ph.D. Thesis, The Univ. of WI. Madison, 1973.

Polaris Mine. Annual Reports - Water Licence. Rep. to NWT Water Board.

Poling, G. W. Environmental Considerations in Tailing Disposal. CIM Bull., v. 72, No. 801, 1979, pp. 144-153.

Poling, G. W. Environmental Consideration in Tailings Disposal. BuMines IC 8818, 1980.

Poopetch, T., P. Limpsaichol, and P. Rojanavipart. Potential Effect of Offshore Tin Mining on Marine Ecology. Ch. in Proc. of the Working Group Mtg. on Environ. Management in Miner. Resour. Develop. United Nations, No. 49, 1982, pp. 70-74.

Portmann, J. E. Possible Dangers of Marine Pollution as a Result of Mining Operations for Metal Ores. Ch. in Marine Pollution and Sea Life, ed. by M. Ruivo, FAO-UNIPUB, 1973, pp. 343.

Portmann, J. E. Marine Pollution by Mining Operations, With Particular Reference to Possible Metal-Ore Mining. Joint IAEA/IMCO/FAO/UNESCO/WMO/WHO Group of Experts on the Scientific Aspects of Marine Pollution, UNESCO HQ, Paris, 1979.

Portmann, J. E., and A. Preston. Sources and Assessment of Pollution. Proc. Conf., Inst. of Civil Eng., London, 1980.

Portmann, J. E., and M. G. Norton. Disposal to Sea of Toxic Materials. Chem. and Ind., v. 8, 1981, pp. 285-290.

Pritchard, P. H. Fate of Environmental Pollutants. J. Water Pollut. Control Fed., v. 56, No. 6, 1984, pp. 718.

Province of British Columbia. Regulations Respecting the Authorization to Deposit Deleterious Substances in Mill Process Effluent From the Operation of the Kitsault Mine into the Waters of Alice Arm, British Columbia. The Alice Arm Tailings Deposit Regulations.

Province of British Columbia, Ministry of Environment. Pollution Control Permit No. PE4335, Climax Molybdenum Corporation of British Columbia Limited at Alice Arm, British Columbia.

Read, A. D., and R. M. Manser. Residual Flotation Reagents Problem in Effluent Disposal and Water Recycle. Proc. 11th Int. Min. Proc. Congr., 1975, pp. 1323-1344.

Rees, C. The Ecological Impact of Manganese Nodule Mining. J. of the Soc. for Underwater Technol., v. 3, No. 3, 1977, pp. 24-26.

Reim, K. General Comments on EPA's Tentative Denial of Pacific Coast Molybdenum Company's Quartz Hill Project NPDES Permit Application (No. AK-004043-6). U. S. Borax & Chem. Corp., CA., 1990, 27 pp.

Reim, K. Position Paper on Quartz Hill Tailings Disposal. U. S. Borax, 1990, 7 pp.

Reim, K. M. Regulatory Changes, Delays and Associated Costs, Quartz Hill Molybdenum, Project Southeast Alaska. AIME Annu. Meet., 1983, 10 pp.

Reish, D. J., G. G. Geesey, T. J. Kawling, F. G. Wilkes, A. J. Mearns, P. S. Oshida, and S. S. Rossi. Marine and Estuarine Pollution. J. Water Pollut. Control Fed., v. 52, 1980, p. 1533.

Reish, D. J., G. G. Geesey, F. G. Wilkes, P. S. Oshida, A. J. Mearns, S. S. Rossi, and T. C. Ginn. Marine and Estuarine Pollution : Water Pollution Literature Review. J. Water Pollut. Control Fed., v. 55, 1983, pp. 767.

Reish, D., S. S. Rossi, A. Mearns, P. S. Oshida, and F. G. Wilkes. Marine and Estuarine Pollution. J. Water Pollut. Control Fed., v. 51, No. 6, 1979, pp. 1477-1516.

Rice, T. SCOR Working Group 7b (Ecology of the Deep Sea Floor). Hamburg Symp. Deep Sea Newsletter, v. 11, 1985, pp. 6-7.

- Roby, R. N. An Environmental Analysis of a Simulated Sea-floor Mining Operation. Preprint 8th Annu. Conf. and Expos. Mar. Tech. Soc., Applica. of Mar. Tech. to Human Needs, 1972, pp. 375-380.
- Roels, O. A., A. F. Amos, C. Garside, and T. C. Malone. The Environmental Impact of Deep-sea Mining. Preprint 8th Annu. Conf. and Expos. Mar. Tech. Soc., Applica. of Mar. Tech. to Human Needs, 1972, pp. 369-373.
- Roy, K. J., and S. V. Smith. Sedimentation and Coral Reef Development in Turbid Water: Fanning Lagoon. Pac. Sci., Univ. of HI., 1971.
- Rusanowski, P. C. Offshore Mining in Relation to Disturbance/Enhancement of the Marine Habitat. Testimony Pres. to the Subcommittee on Min. and Natur. Resour., of the Committee on Interior and Insular Affairs, 1989, 7 pp.
- Scarratt, D. J. Fisheries' Interest and Ocean Mining. Mar. Min., v. 6, No. 2, 1987, pp. 141-147.
- Sceva, J. E. Water Quality Considerations for the Metal Mining Industry in the Pacific Northwest. EPA, Reg. X, Seattle, WA., Rep., No. 3, 1973.
- Schafer, H. A., G. P. Hershelman, D. R. Young, and A. J. Mearns. Contaminants in Ocean Food Webs. Ch. in Coastal Water Res. Project, Biennial Rep. 1981-1982, ed. by W. Bascom, 1982, pp. 17-28.
- Schaumburg, F. D. Judgment Reserved; A Landmark Environmental Case. Reston Publishing Co., Inc., Reston, VA., 1976.
- Schell, W. R., and A. Nevissl. Heavy Metals from Waste Disposal in Central Puget Sound. Environ. Sci. Tech., v. 11, No. 9, 1977, pp. 887-893.
- Schubel, J. R. and D. J. Hirschberg. Estuarine Graveyards, Climatic Change, and the Importance of the Estuarine Environment. Ch. in Estuarine Interactions, ed. by M. L. Wiley, Acad., 1978.
- Seatech. Data Report for the Pre-Discharge Period to April 1972. Dobrocky Seatech Ltd. Rep. to Jordan River Mines Ltd., 1972, 52 pp.
- Seatech. Diver Inspection of the Seabottom, and Flora and Fauna Near the Jordan River Mines Tailings Discharge Pipe. Dobrocky Seatech Ltd. Rep. to Jordan River Mines Ltd., 1973, 10 pp.
- Seatech. First Annual Report of the Monitoring and Surveillance Programme at Jordan River Mine. Dobrocky Seatech Ltd. Rep. to Jordan River Mines Ltd., 1973, 73 pp.
- Segar, D. A. An Assessment of Great Lakes and Oceans Pollution Monitoring in the United States. Working Paper: Federal Plan for Ocean Pollut. Res. Develop. and Monitoring, FY, 1981-1985, Boulder, CO., No. 7, 1981.
- Serra, R. E. Report on Northwest Regional Workshop in Ocean Pollution Monitoring. U. S. Dep. of Commerce, NOAA, OMPA, Seattle, WA. Jan. 6-8, 1981.
- Shanks, N. We Close Mine Unless You Pay. Victoria Times Colonist, 1975.
- Sharp-Paul, A., N. Makap, K. Watoka, and B. Tapari. Environmental Data Report March 1978, Ok Tedi Project. Ok Tedi Environmental Task Force, Office of Environment and Conservation, Waigani, PNG, 1978, 83 pp.
- Sherk, J. A., J. M. O'Connor, and D. A. Neumann. Effects of Suspended and Deposited Sediments on Estuarine Environments. Ch. in Estuarine Res., Geol. and Eng., ed. by L. E. Cronin, Acad., 1975, pp. 541-558.
- Sloan, N. F. Environmental Impact of Tailings Basin Construction and Effluent Discharge. Contract/Grant No. 0068419; MICZ020231,.
- Sly, G. Some Influence of Dredging in the Great Lakes. Centre for Inland Waters, Burlington, Ontario, Canada,.
- Smith, D. D. Dredged Material, Ocean Disposal, and the Regulatory Maze. Ch. in Ocean Dumping and Mar. Pollut., ed. by H.D. Palmer, and M.G. Gross, Dowden, Hutchinson and Rose, Inc., Stroudzberg, PA., 1979.

Smith, D. D., and W. E. Pequegnat. Ocean Dumping of Dredged Material Major Environmental Consideration Site-selection Procedures. Am. Assoc. of Pet. Geol.-Soc. of Econ. Paleontol. and Mineral. Joint Sess., Wash., D. C., 1977, 84 pp.

Snitz, F. L., W. J. Weber, Jr., J. L. Barney, and J. C. Posner. Effects of Calcium and Sediment Concentrations on the Release of Metals and Nutrients From Dredged Spoil Dispersions. Ch. in Aquat. Toxicol., ASTM STP 667, ed. by L. L. Marking, and R. A. Kimerle, 1979, pp. 322-341.

Southern Peru Copper Corporation. Marine Environmental Studies/ITE Peru. Prepared by Dames & Moore, NY., 1976.

Southgate, T., D. J. Slinn, and J. F. Eastham. Mine-Derived Metal Pollution in the Isle of Man. Mar. Pollut. Bull., v. 14, 1983, pp. 137-140.

Springer - Verlag. Environmental Management of Solid Waste Dredged Material and Mine Tailings. V. 10, 1988, 396 pp.

Stanley, D. J., and D. J. P. Swift. Marine Sediment Transport and Environmental Management. Under the Auspices of the Am. Geol. Inst., Wiley-Intersci.

Steering Committee on Coastal Wastes Management (ed.). Wastes Management Concepts for the Coastal Zone; Requirements for Research and Investigation. Natl. Acad. of Sci., v. VII, 1970, 126 pp.

Stern, E. M., and W. B. Stickle. Effects of Turbidity and Suspended Material in Aquatic Environments. Dredge Res. Program, Tech. Rep. D-78-21, Environ. Lab., U. S. Army Eng. Waterways Experiment Station, Vicksburg, MS., 1978, 177 pp.

Strong, P. L. Composition of Quartz Hill Alaskan Environmental Water Samples (1977). 1977, 24 pp.

Swanson, R. L., and M. Devine. Ocean Dumping Policy, The Pendulum Swings Again. Environ., v. 24, No. 5, 1982, pp. 15.

Temple, T. Reserve Mining Ends Lake Dumping. EPA, J., v. 6, No. 6, 1980, pp. 4.

Thiel, H. Man's Impact on the Deep-Sea. Deep Sea Newsletter, v. 11, No. 6, 1985.

Thiel, H., and G. Schriever. DISCOL -The First Large Scale Deep-Sea Impact Study. Deep-Sea Newsletter, No. 16, 1989, pp. 31-34.

Thiel, H., and G. Schriever. Deep-Sea Mining, Environmental Impact and the DISCOL Project. Ambio., v. 19, No. 5, 1990, pp. 245-250.

Thomann, R. V. Equilibrium Model of Fate of Microcontaminants in Diverse Aquatic Food Chains. Can. J. of Fish. and Aquat. Sci., v. 38, 1981, pp. 280-296.

Thomas, D. J., and S. Metikosh. The Effect of a Lead-Zinc Mining Operation on the Marine Environment of Strathcona Sound, NWT. Can. Proc. Conf. Environ. Contam., London, 1984, PP. 561-566.

Thompson, J. A. J. Copper in Marine Waters-Effects of Mining Wastes. Proc. Int. Conf. Heavy Metals in Environ. Toronto Canada, Oct. 27-31, 1975.

U. S. Environmental Protection Agency. Quality Criteria For Water 1986. Update #2. U. S. EPA Criteria and Standard Div., Washington, D. C., 1987.

U. S. Environmental Protection Agency. Quality Criteria for Water 1986. EPA 440/5-86-001. U. S. EPA Office of Water Regulations and Standards. Washington, D. C., 1986.

U. S. Environmental Protection Agency. Technical Support Document for Water Quality-Based Toxics Control. Office of Water, Washington, D. C., 1985, 104 pp.

- U. S. Environmental Protection Agency. Ambient Water Quality Criteria for Copper. EPA 440/5-84/031. Natl. Tech. Inf. Serv., Springfield, VA., 1985, 142 pp.
- U. S. Environmental Protection Agency. Ambient Water Quality Criteria for Arsenic. Office of Water Regulation and Standards, Washington, D. C. EPA 440/5-80-025, 1980.
- U. S. Environmental Protection Agency. Ambient Water Quality Criteria for Cadmium. Office of Water Regulations and Standards, Washington, D. C. EPA 440/5-80-058, 1980.
- U. S. Environmental Protection Agency. Ambient Water Quality Criteria for Copper. Office of Water Regulations and Standards, Washington, D. C. EPA 440/5-80-036, 1980.
- U. S. Environmental Protection Agency. Ambient Water Quality Criteria for Mercury. Office of Water Regulations and Standards, Washington, D. C. EPA 440/5-80-057, 1980.
- U. S. Environmental Protection Agency. Ambient Water Quality Criteria for Lead. Office of Water Regulations and Standards, Washington, D. C. EPA 44/5-80-057, 1980.
- U. S. Environmental Protection Agency. Ambient Water Quality Criteria for Zinc. Office of Water Regulations and Standards, Washington, D. C. EPA 440/5-80-079, 1980.
- U. S. Environmental Protection Agency. Ambient Water Quality Criteria for Cyanides. Office of Water Regulations and Standards, Washington, D. C. EPA 440/5-80-037, 1980.
- U. S. Environmental Protection Agency. Water Quality Criteria Documents; Availability. Federal Register, Part V, 1980, pp. 79318-79379.
- U. S. Environmental Protection Agency. Ambient Water Quality Criteria for Chromium. Office of Water Regulations and Standards, Washington, D. C. EPA 440/5-80-035, 1980.
- U. S. Environmental Protection Agency. Ambient Water Quality Criteria for Nickel. Office of Water Regulations and Standards, Washington, D. C. EPA 440/5-80-070, 1980.
- U. S. Environmental Protection Agency. Ambient Water Quality Criteria for Selenium. Office of Water Regulations and Standards. Washington, D. C. EPA 440/5-80-071, 1980.
- U. S. Environmental Protection Agency. Ambient Water Quality Criteria for Silver. Office of Water Regulations and Standards. Washington, D. C. EPA 440/5-80-072, 1980.
- U. S. Environmental Protection Agency. Quality Criteria for Water. United States GPO. Washington, D. C., 1976.
- U.S. Environmental Protection Agency. Draft Ecological Risk Assessment, Quartz Hill Molybdenum Project. Final Draft Rep. Seattle, WA., 1988.
- U.S. Environmental Protection Agency. Ocean Discharge Criteria Evaluation. Quartz Hill Mill Tailings Dispersal. 1985.
- U.S. Environmental Protection Agency. Final Draft, Ecological Risk Assessment, Quartz Hill Molybdenum Project. 1988.
- U.S. Forest Service. Draft Environmental Impact Statement. Quartz Hill Molybdenum Project Mine Development. Administrative Document 133, 1984.
- U.S. Forest Service (ed.). Quartz Hill Molybdenum Project Mine Development. Record of Decision. U. S. Dep. Agric., For. Serv., Tongass Natl. For. R10-MB-45, 1988, 18 pp.
- United Nations. IMCO/FAO/UNESCO/WMO/WHO/IAEA/UN, Joint Group of Experts on the Scientific Aspects of Marine Pollution -- GESAMP, Review of Harmful Substances. Rep. and Studies, No. 2, 1976.

United States Borax & Chemical Corp. Draft Environmental Report, Development of Quartz Hill Molybdenum Project, Alaska. I, 1983.

United States Borax & Chemical Corp. Draft Environmental Report. II, 1983.

USDA, Forest Service, Alaska Region. Draft Mining Development Concepts Analysis Document, U.S. Borax Molybdenum Claims at Quartz Hill. Rep. No. 129, 1981.

USDA, Forest Service, Alaska Region. Draft Environmental Impact Statement: U. S. Borax 1980-83 Operating Plan, Amendments 2, 3, and 4, for the Quartz Hill Molybdenum Claims, Tongass National Forest, Alaska. Rep. No. 171, 1983.

USDA, Forest Service, Alaska Region. Final Environmental Impact Statement: U. S. Borax 1980-83 Operating Plan, Amendments 2, 3, and 4 for the Quartz Hill Molybdenum Claims, Tongass National Forest, Alaska. Rep. No. 172, 1983.

USDA, Forest Service, Alaska Region. Final Environmental Impact Statement on Standards and Guidelines, Alaska Regional Guide. Rep. No. 126b, 1983. 1.

USDA, Forest Service, Alaska Region. Misty Fjords National Monument Wilderness, Environmental Assessment and Management Plan. 1984.

USDA, Forest Service, Alaska Region. Quartz Hill Molybdenum Project Mine Development, Environmental Impact Statement. Preliminary Draft. 1983.

USDA, Forest Service, Ketchikan Area, R-10. Quartz Hill Molybdenum Project Mine Development, Final Environmental Impact Statement. V. 1, 1988.

USDA, Forest Service, Ketchikan Area, R-10. Quartz Hill Molybdenum Project Mine Development, FEIS, Appendices. V. 2, 1988.

USDA, Forest Service, Ketchikan Area, R-10. Quartz Hill Molybdenum Project Mine Development, FEIS, Comments and Responses. V. 3, 1988.

USDA, Forest Service, Alaska Region. Quartz Hill Molybdenum Project Mine Development, Appeal #3080, Responsive Statement of the Deciding Officer. 1990.

Utah Mine, Ltd. Island Copper Mine. Annu. Environ. Assess. for 1985, v. I & II, 1986.

Uthe, J. F., and V. Zitko (eds). Cadmium Pollution of Belledune Harbour, N. B. Canada. Can. Tech. Rep. Fish. Aquat. Sci., v. 963, 1980, 107 pp.

Vancouver Sun. Scientist Says Mine Dump No Danger to Inlet Species. 1973.

VanderZwaag, D., S. Mills, and B. Patton. Environmental Law in Indonesia and Canada. Proc. Workshop 1985 EMDI Dalhousie U, 1987, 299 pp.

Venables, W. N., and E. E. Pearlman. Public Inquiry into the Application from Utah Construction and Mining Co. B. C. Govt. Rep., 2 Vols., 1970.

Vermeer, R. A. An Economic Assessment of a Pollution Externality: The Case of Utah Mines. MA Thesis, Univ. Victoria, 1979.

VTN Consolidated, Inc. 1981 Boca de Quadra Monitoring Study, Quartz Hill Molybdenum Project, Southeast Alaska. U. S. Borax & Chem. Corp., Los Angeles, CA., 1982.

VTN Consolidated, Inc. (ed.). Boca de Quadra Baseline Report. Quartz Hill Molybdenum Project, Southeast Alaska. Rep. U. S. Borax, 1980.

VTN Consolidated, Inc. (ed.). Wilson Arm/Smeaton Bay Baseline Report. Coastal and Marine Biology Program. Quartz Hill Molybdenum Project, Southeast Alaska. Rep. U. S. Borax, 8 Sects. and Appendices, 1981.

VTN Consolidated, Inc. 1980 Air Resources, Annual Environmental Baseline Report, Quartz Hill Molybdenum Project, Southeast Alaska. 1980.

VTN Consolidated, Inc. 1980 Aquatic Biology, Annual Environmental Baseline Report, Quartz Hill Molybdenum Project, Southeast Alaska. 1980.

VTN Consolidated, Inc. Coastal and Marine Biology Report, Annual Environmental Baseline Report, Quartz Hill Molybdenum Project, Southeast Alaska. 1980.

VTN Consolidated, Inc. 1980 Surface Hydrology and Water Quality, Annual Environmental Baseline Report, Quartz Hill Molybdenum Project, Southeast Alaska. 1980.

VTN Consolidated, Inc. 1981 Aquatic Biology, Annual Environmental Report, Quartz Hill Molybdenum Project 12. 1981.

VTN Consolidated, Inc. 1982 Air Resources, Annual Environmental Report. 1982.

VTN Consolidated, Inc. Integrative Data Analysis, Coastal and Marine Biology Program, Quartz Hill Molybdenum Project, Southeast Alaska. 1983.

VTN Consolidated, Inc. Boca de Quadra and Wilson Arm/Smeaton Bay Monitoring Study. Annu. Environ. Rep., 1982.

VTN Consolidated, Inc. Environ. Reconnaissance Rep., Quartz Hill Molybdenum Project, Southeast Alaska. 1977.

Waldichuk, M. Coastal Marine Pollution and Fish. Ocean Management, v. 2, 1974, pp. 1-60.

Waldichuk, M. Pollution by Abandoned Mines. Mar. Pollut. Bull., v. 18, No. 8, 1987, pp. 422-423.

Waldichuk, M. An Environmental Assessment and Review Process. Mar. Pollut. Bull., v. 14, No. 11, 1983, pp. 405-408.

Waldichuk, M. Federal Marine Pollution Monitoring Programs - Canada. Rep. of Northwest Regional Workshop on Ocean Pollution Monitoring, Seattle, WA., Jan. 6-8, 1981, pp. D-75.

Waldichuk, M. Canadian Activities in the Pacific Region Related to Ocean Science and Marine Pollution Research. Ch. in the North Pac. Project, ed. by C. L. Dawson, Proc. Rev. Conf., Univ. Washington, Jul. 27-29, Inst. Mar. Res. Univ. Washington, Seattle, WA., IMS Publ. Ser. IMS-77-1, 1977, pp. 549-561.

Waldichuk, M. Review of the Problem: Sublethal Effects of Pollutants in the Sea. Phil. Trans. R. Soc. Lond. B., v. 286, 1979, pp. 399-424.

Waldichuk, M. Waste Disposal in Relation to the Physical Environment-Oceanographic Aspects. Syesis, v. 1, No. 1 & 2, 1968, pp. 4-27.

Waldichuk, M. Control of Marine Pollution: An Essay Review. Ocean Dev. Int. Law, v. 4, 1977, pp. 269.

Waldichuk, M., and R. J. Buchanan. Significance of Environmental Changes due to Mine Waste Disposal into Rupert Inlet. Federal/Provincial Rev. of the Mine Waste Disposal Problem in Rupert Inlet, B.C. Fish. and Oceans Canada and B.C. Ministry of Environ., 1980.

Wall Street Journal. Reserve Mining Replies to Pollution Charge. 1972, p. 34.

Walsh, D. Implications of the National Advisory Committee on Oceans and Atmosphere (NACOA) Report, The Role of the Oceans in Waste Management Strategy. Ch. in Waste Disposal in the Oceans, Minimizing Impact, Maximizing Benefits, ed. by D. F. Soule and D. Walsh, Westview, 1983.

- Walsh, J. P. U. S. Policy on Marine Pollution: Changes Ahead. *Oceanus*, v. 24, 1981, pp. 18-24.
- Ward, T. J., L. J. Warren, and K. L. Tiller. The Distribution and Effects on the Marine Environment Near a Lead-Zinc Smelter, South Australia. Ch. 1 in *Environ. Impact of Smelters*. Nriagu, JO. Wiley, 1984, pp. 1-73, 608 pp.
- Warren, L. J. Contamination of Sediments by Lead, Zinc and Cadmium: A Review. *Environ. Pollut., Series B*, v. 2, No. 6, 1981, pp. 401-436.
- Wastler, T. A. Ocean Dumping Permit Program Under the London Dumping Convention in the United States. *Chemosphere*, v. 10, No. 6, 1981, pp. 659-668.
- Wastler, T. A., and L. C. Wastler. Estuarine and Coastal Pollution in the United States. Ch. in *Mar. Pollut. and Sea Life*, ed. by M. Ruivo, FAO UNIPUB, 1973, pp. 40.
- Water Qual. Int. Philippine Copper Mine Ordered Shut. V. 2, No. 4, 1988.
- Weidemann, H., and H. Sendner. Dilution and Dispersion of Pollutants by Physical Processes. Ch. in *Mar. Pollut. and Sea Life*, ed. by M. Ruivo, Food and Agri. Org. of the United Nations (FAO), 1973, pp. 115-121.
- West, R. River of Tears. Earth Island, London, 1972, pp. 201.
- White, H. H. (ed.). Concepts in Marine Pollution Measurements. Univ. Maryland. College Park, 1984, 743 pp.
- Wilson, K. W., and P. M. Connor. The Effect of China Clay on the Fish of St. Austell and Mevagissey Bays. *J. Mar. Biol. Assoc.*, v. 56, 1976, pp. 769-780.
- Windom, H. L. Water-Quality Aspects of Dredging and Dredge-Spoil. Vicksburg, MS., 1978.
- Wohlschlag, D. E., and J. B. Copeland. Fragile Estuarine Systems - Ecological Considerations. *Water Res. Bull.*, v. 6, No. 1, 1970, pp. 94-105.
- Wong, M. H. Environmental Impacts of Iron Ore Tailings - The Case of Tolo Harbour, Hong Kong. *Environ. Mgmt.*, v. 5, No. 2, 1981, pp. 135-145.
- Wong, M. H., K. C. Chan, and C. K. Choy. The Effect of the Iron Ore Tailings on the Coastal Environment of Tolo Harbor, Hong Kong. *Environ. Res.*, v. 15, No. 3, 1978, pp. 342-356.
- Wongchumpit, O. Environmental Impact Study of Offshore Tin Mining Near Phuket Island, Thailand. E-W Centre Work. Pap., v. 58, 1985.
- Woods Hole. Second International Ocean Dumping Symposium Program and Abstracts. 1980, pp. 15-18.
- Wright, T. D. Aquatic Dredged Material Disposal Impact. Tech. Rep. DS-78-1, U. S. Army Eng. Waterways Experiment Station, Vicksburg, MS., 1978.
- Wright, T. D., D.G. Leddy, D. J. Brandt, and T. T. Virnig. Water Quality Alteration of Torch Lake, Michigan by Copper Leach Liquor. Proc. 16th Conf. Great Lakes Res., Int. Assoc. Great Lakes Res., 1973, pp. 329-344.
- Wrobel, W. E. Benchmark Water Resources Monitoring Manual, Quartz Hill Molybdenum Project, Southeast Alaska. VTN Consolidated, Inc., 1983.
- Yeo, R. K., and M. J. Risk. Fundy Tidal Power: Environmental Sedimentology. *Geosci. Can.*, v. 6, No. 3, 1979, pp. 115-121.
- Yim, W. W. S. Heavy Metal Accumulation in Estuarine Sediments in a Historical Mining of Cornwall. *Mar. Pollut. Bull.*, v. 7, No. 8, 1976, pp. 147-150.

Young, D. R., D. J. McDermott, T. C. Heesen and T. K. Jan. Pollutant Inputs and Distributions off Southern California. Ch. in *Mar. Chem. in the Coastal Environ.*, ed. by T. M. Church, Washington, D. C. Am. Chem. Soc., 1975, pp. 424-439.

Young, D. R., T. K. Jan and T. C. Heesen. Cycling of Trace Metal and Chlorinated Hydrocarbon Wastes in the Southern California Bight. Ch. in *Estuarine Interactions*, ed. by M. L. Wiley, Acad., 1978, pp. 481-496.

Zippin, J. P. Draft Environment Impact Statement. Gorda Ridge Area. Miner. Management Service. U. S. Dept. Interior, 1983, 580 pp.

Technical Citations

- Abdullah, M. I., L. G. Royle, and A. W. Morris. Heavy Metal Concentrations in Coastal Waters. *Nature Lond.*, v. 235, 1972, pp. 158-159.
- Abu Gideire, Y. B. Implications of Sea Mining for the Red Sea Environment. *Hydrobiologia*, v. 110, 1984, pp. 15-19.
- Ackerman, D. H. Environmental Planning Modern Mineral Development. V. 56, No. 4, 1970, pp. 40-36.
- Amann, H. The Red Sea Pilot Project: Lessons for Future Ocean Mining. *Mar. Min.*, v. 8, No. 1, 1989, pp. 1-22.
- Amann, H. Development of Ocean Mining in the Red Sea. *Mar. Min.*, v. 5, No. 2, 1985, pp. 103-116.
- Amax of Canada Limited. A Perspective on Mill Tailing Disposal at Kitsault, British Columbia. 1981.
- Amos, A. F., C. Garside, K. C. Haines, and O. A. Roels. Effects of Surface-Discharged Deep Sea Mining Effluent. *Mar. Tech., Soc. J.*, v. 6, No. 4, 1972, pp. 40-45.
- Aplin, C. L., and G. O. Argall Jr. (eds.). *Tailing Disposal Today*. Miller Freeman, 1972, 552 pp.
- Avery, D. Not on Queen Victoria's Birthday. *The Story of Rio Tinto Mines*. Collins, London, 1974, 464 pp.
- B. C. Research. Baseline Survey of the Marine Environment at Strathcona Sound. N.W.T. Project 1552, Prog. Rep., Prepared for Strathcona Miner. Services, No. 1, 1975.
- B. C. Research. The Disposal of Mining and Milling Wastes with Particular Reference to Underwater Disposal. Prepared for Dep. of Lands, Forests and Water Resour., Water Resour. Service, Province of B. C., 1970.
- Bain, A. G., and S. T. Bonnington. *The Hydraulic Transport of Solids by Pipeline*. Pergamon, 1970.
- Barker, J. C. Marine Placer Development and Opportunities in Alaska. *Offshore Technol. Conf.* 6105.
- Barnard, W. Generation of Turbid Plumes. Ch. in *An Investigation of Turbidity Control Methods for use on Tin Dredges Operation off the West Coast of Thailand*. United Nations Environ. Programme, 1978, pp. 26-31.
- Barnard, W. D. Prediction and Control of Dredged Material Dispersion Around Dredging and Open-Water Pipeline Disposal Operations. Tech. Rep. DS-78-13, U. S. Army Eng. Waterways Experiment Station, Vicksburg, MS., 1978.
- Barth, R. C. Reclamation Technology for Tailing Impoundments. *Colorado School of Mines, (Min. & Energy Resour.)*, v. 29, No. 1-2, 1986, pp. 192-6179.
- Bear, J. *Dynamics of Fluids in Porous Media*. Am. Elsevier, 1972.
- Bechtel Civil & Minerals, Inc. Boca de Quadra Water Column Stability Analysis for the Development of Quartz Hill Molybdenum Project, Alaska. 1984.
- Bechtel Civil and Minerals, Inc. Behavior of the Tailings Plume in the Near Field. *Submarine Tailings Disposal Studies*, Appendix D. Quartz Hill Molybdenum Project, 1983.
- Bechtel Civil and Minerals, Inc. Fjord Circulation/Transport Model of Boca de Quadra Fjord for Quartz Hill Molybdenum Project, Southeast Alaska. Status Rep., Attached to Letter No. 14991-BLU-1346, 1984.
- Bedford Institute of Oceanography. *The Symposium on the Dynamics of Turbid Coastal Environments*. 1981.
- Bell, A. V. Waste Controls at Base Metal Mines. *Environ. Sci. Technol.*, v. 10, 1976, pp. 130-135.
- Bell, A. V., and D. R. Nancarrow. Salmon and Mining in Northeastern New Brunswick. *Cim. Bull.*, v. 67, 1974, pp. 44-53.

- Bell, A. V., K. D. Phinney, and S. W. Behie. Some Present Experiences in the Treatment of Acidic Metal Bearing Mine Drainages. *Cim. Bull.*, v. 68, 1975, pp. 39-46.
- Bell, H. S. Stratified Flow in Reservoirs and its Use in Prevention of Silting. Misc. Publ., U. S. Dep. of Agriculture, No. 491, 1942.
- Bell, W. H. The Exchange of Deep Water in Howe Sound Basin. *Pac. Mar. Sci. Rep. Environ. Can., Fish. and Mar. Ser.*, No. 73-13, 1973, 35 pp.
- Bender, M. Does Upward Diffusion Supply the Excess Manganese in Pelagic Sediments. *J. Geophys. Res.*, v. 76, 1971, 4212 pp.
- Bewers, J. M., and H. L. Windom. Intercomparison of Seawater Sampling Devices for Trace Metals. Ch. in *Trace Metals in Seawater*, ed. by C. S. Wong, et al. NATO Sci. Affairs Div., Plenum, 1983, pp. 143-154.
- Bhappu, R. B., J. H. Fair, and J. R. Wright. Waste Problems Relative to Mining and Milling of Molybdenum. *Eng. Ext. Ser., Proc. 22nd Ind. Waste Conf., Purdue Univ.*, No. 129, 1976, pp. 575-592.
- BHP Ltd. Annual Reports. Previously Annual Reports of General Electric, Utah Mining and Construction for IC.
- Bhra Fluid Engineering. International Conference on the Hydraulic Modelling of Civil Engineering Structures. Coventry, England, 1982.
- Bigham, G. N., and T. Ginn. Ocean Disposal of Manganese Nodule Processing Wastes. Ch. in *Coastal Zone '83, Proc. Third Symp. on Coastal and Ocean Management*, ed. by O. T. Magoon, and H. Converse, San Diego, CA., Jun. 1-4, 1983.
- Billingsley, J. R. Underground Mining and Milling at Cowichan Copper Co. Ltd. *CIM.*, v. 58, 1965, pp. 297-303.
- Bloch, A. *Murphy's Law and Other Reasons Why Things go Wrong*. Price Stern Sloan, 1979, 96 pp.
- Bohlen, W. F., D. F. Cundy, and J. M. Tramontano. Suspended Material Distributions in the Wake of Estuarine Channel Dredging Operations. *Estuarine and Coastal Mar. Sci.*, v. 9, 1979, pp. 699-711.
- Bokuniewicz, H. C. Stability and Fate of Dredged Material. *Proc. 11th Dredging Seminar*, T. A&M Univ., Cent. for Dredging Studies CDS Rep., State Univ. of N.Y. at Stony Brook, Mar. Sci. Res. Cen. Con., 1979, 228 pp.
- Bokuniewicz, H. C., and R. B. Gordon. Containment of Particulate Waste in Marine Environment. *Am. Assoc. of Pet. Geol.-Soc. of Econ. Paleontologists and Mineral. Joint Sess., Wash., D.C.*, 1977, 83 pp.
- Boone, C. G., M. A. Grant, and M. P. Farrell. Aquatic Disposal Field Investigations, Columbia River Disposal Site, Oregon: Evaluative Summary. *Tech. Rep. D-77-36*, U.S. Army Eng. Waterways Experiment Station, Vicksburg, MS., 1978.
- Born, C. A. and W. D. Lenton. The Kitsault Project. 81st Annu. Mtg. *Can. Inst. Min. Metall.*, Montreal, Quebec, 1979.
- Bornyhold, B. D. Sedimentation in Douglas Channel and Kitimat Arm. Ch. in *Can. Tech. Rep. Hydrog. and Ocean Sci.*, 18, ed. by R. W. MacDonald, 1983, pp. 88-114.
- Bougainville Copper Ltd. . Annu. Rep., Papua New Guinea, 1989.
- Bougainville Copper Mine (ed.). *Environmental Planning and Research*. Bougainville Copper Ltd. Panguna Mine, 1979, 29 pp.
- Bradley, W. H. Vertical Density Currents. *Sci.*, v. 150, 1965, pp. 1423-1428.
- Brandsma, M. G., and D. J. Divoky. Development of Models for Prediction of Short-Term Fate of Dredged Material Discharged in the Estuarine Environment. *Tech. Rep. CR-76-5*, U.S. Army Eng. Waterway Experiment Station, Vicksburg, MS., Prepared by Tetra Tech., Inc., TC-406, 1976.

Brandsma, M. G., L. R. Davis, R. C. Ayers Jr., and T. C. Sauer Jr. A Computer Model to Predict the Short-Term Fate of Drilling Discharges in the Marine Environment. Symp., Res. on Environ. Fate and Effects of Drilling Fluids and Cuttings, Lake Buena Vista, FL, Jan. 21-24, 1980.

Brawner, C. O. Concepts and Experience for Subsurface Storage of Tailings. Tailing Disposal Today, Proc. of the 2nd Int. Tailing Symp., Denver, CO., May 21-25, 1978, Miller Freeman, 1979, pp. 153-177.

Brown, M. J. F. A Development Consequence - Disposal of Mining Waste on Bougainville, Papua, New Guinea. Geoforum, v. 18, 1974, pp. 19-27.

Brown, O. K., and G. J. Sheflott. Tailings Disposal and Reclamation Concepts at Two Diverse Locations. SME-AIME Annu. Mtg. Los Angeles, CA., Feb. 26 - Mar. 1, 1984.

Brown, R. J. Ocean Waste Disposal, 1964-1976; A Bibliography With Abstracts. NTIS/PS-78/0705, v. 1, 1978.

Brown, R. J. Ocean Waste Disposal, 1977; A Bibliography with Abstracts. NTIS/PS-78/0706, v. 2, 1978.

Brown, R. J. Ocean Waste Disposal, 1977, (Citations From the NTIS Data Base). NTIS/PS-801, 1980.

Bruyakin, Y. V., Y. V. Bubis, and L. N. Molochnikov. Fundamentals of Seafloor Minerals Mining Technology. Mar. Min., v. 8, No. 4, 1989, pp. 457-467.

Buchanan, R. J. A Government Inquiry into Mine Waste Disposal at Island Copper Mine. Ch. in Mar. Tailings Disposal, ed. by D. V. Ellis. Ann Arbor Sci., 1982, pp. 255-270.

Buckmaster, M. A. Analysis of Chemical Grouts as a Tailings Amendment and an Environmental Assessment of Metallurgically Reprocessed Tailings. V. 8, 1989, 87 pp.

Burling, R. M., J. E. McInerney, and W. K. Oldham. Interim Report, Amax Scientific Review Panel. Letter to Minister, Fish. and Oceans, Canada, 1982.

Burling, R. W. Deep Circulation in Inlets: Indian Arm as a Case Study. Ch. 3 in Marine Tailings Disposal, ed. by D. V. Ellis. Ann Arbor Science, 1982, pp. 85-132.

Burling, R. W., J. E. McInerney, and W. K. Oldham. A Continuing Technical Assessment of the Amax/Kitsault Molybdenum Mine Tailings Discharge to Alice Arm, British Columbia. Rep. Ministry Fish. and Oceans, Ottawa, 1983, 65 pp.

Burling, R. W., McInerney, J. E., and W. K. Oldham. A Technical Assessment of the Amax/Kitsault Molybdenum Mine Tailings Discharge to Alice Arm, British Columbia. Rep. Ministry Fish. and Oceans, Ottawa, 1981, 154 pp.

Burns, R. E., B. H. Erickson, J. W. Lavelle, and E. Ozturgut. Observations and Measurements During the Monitoring of Deep Ocean Manganese Nodule Mining Tests in the North Pacific, March - May 1978. NOAA, Environ. Res. Lab., Mar. Ecosyst. Anal. Program, 1980.

Burrell, D. C. Seasonal Turbidity Patterns in Boca de Quadra and Smeaton Bay. Interim Rep., 1984.

Burrell, D. C. Interaction Between Silled Fjords & Coastal Regions of the Gulf of Alaska. Ch. 7, 1986.

Burrell, D. C. The Oceanography of Alaska Estuaries. Text of Talk Given at the U. S. Borax - Sponsored Tech. Seminar, Ketchikan Community College, 1980.

Burton J. R. Bougainville Copper's Environmental Management Program - A Review and Appraisal. Rep. Bougainville Copper Ltd. BCM Rep. RC 113, 1984, 92 pp.

Byrne, J. V., et. al. Disposal in the Marine Environment: An Oceanographic Assessment. Natl. Res. Council, Washington, D. C., PB-274 056, 1976.

Cairns Jr., J. (ed.). Artificial Substrates. Ann Arbor Sci., 1982.

- Caldwell, J. A., and A. M. Robertson. Selection of Tailings Impoundment Sites. Manuscript, 1983, 30 pp.
- Caldwell, J. A., and J. D. Welch. Tailings Disposal in Rugged, High Precipitation Environments. Ch. in *Mar. Tailings Disposal*, ed. by D. V. Ellis, Ann Arbor Sci., 1982, pp. 5-62 (368 pp).
- Capuzo, J. Fifth International Ocean Disposal Symposium. Program and Abstr., OR. State Univ., Corvallis, OR., 1984.
- Carey, J. Nickel Mining and Refinery Wastes in Coral Reef Environs. Paper in Proc. 4th Int. Coral Reef Symp, ed. by R.W. Buddemeier, R.E. Johannes, J.A. Marchs, and R.T. Tsuda, Univ. Philippines, v. 1, 1981, pp. 138-146.
- Cargill, D. C. Geology of the Island Copper Mine, Port Hardy, B. C. Ph.D. Thesis, UBC, 1975.
- Carrillo, F. V. Mining Cobalt Crusts in the Exclusive Economic Zone. Ch. in *Miner. Today*, U. S. BuMines, Washington, D. C., 1991, p. 26.
- Carstens, T. and E. Tesaker. Erosion by Artificial Suspension Current. Pres. at the Thirteenth Coastal Eng. Conf., Vancouver, B. C., 1972.
- Carter, L. The Disposal of Chemical Wastes Through Submarine Pipelines into Tidal Waters. Proc. Conf., Inst. of Civil Eng., London, 1980.
- Castro, S. Flotation of Molybdenite. Ch. in *Int. Molybdenum Encyclopedia 1778-1978*, ed. by A. Sutulov, v. 2, 1979, pp. 164-181.
- Cato, I., I. Olsson, and R. Rosenberg. Recovery and Decontamination of Estuaries. Ch. in *Chem. and Biogeochem. of Estuaries*, ed. by E. Olausson and I. Cato. Wiley, 1980, pp. 403-435.
- Caughill, D. Mining Concepts for Seabed Polymetallic Sulphide Deposits off the West Coast of Canada Co-Op Stud. Work Proj. Rep. Ocean Min. Div., EMR Canada, 1987, 58 pp.
- CBI. Marine Effluent Disposal Scheme for Richards Bay. Campbell Bernstein and Irving for Mhlatuze Water Board, 1982, 6 pp.
- Chander, S., and D. W. Fuerstenau. On the Natural Floatability of Molybdenite. *Transaction of the Am. Inst. of Min. Eng.*, v. 252, 1972, pp. 62-69.
- Chansang, H. Coastal Tin Mining and Marine Pollution in Thailand. *Ambio*, v. 17, No. 3, 1988, pp. 223-228.
- Chave, K. E. and J. N. Miller. Pearl Harbor Dredged-Material Disposal. Ch. in *Waste in the Ocean, Dredged-Mater. Disposal in the Ocean*, ed. by D. R. Kester, B. H. Ketchum, I. W. Duedall and P. K. Park, Wiley, v. 2, 1983, pp. 91-99.
- Chem. & Eng. News. Congress Moves on Mining of Deep Seabed. V. 55, No. 34, 1977, p. 10.
- Chemical Market Report. Amax Canada Resume Molybdenum Operation. V. 219, No. 234, 1981.
- Chin, Y. K. Ocean Disposal of Copper Mining Tailings. Proc. 4th Annu. Offshore Tech. Conf., v. 2, 1972, pp. 415-416.
- CIM. Submarine and Lake Disposal of Mill Tailing. Proc. of XIV Int. Min. Proc. Conf., Sess. No. 10: Round Table, Oct. 17-23, Toronto, 1982, pp. 52-70.
- Clark, A., C. Johnson, and P. Chinn. Assessment of Cobalt-Rich Manganese Crusts in the Hawaiian, Johnston, and Palmyra Islands' Exclusive Economic Zones. *Natur. Resour. Forum*, United Nations, N. Y., 1984, pp. 163-174.
- Cochran, J. R. A Model for Development of the Red Sea. *Am. Assoc. Petrol. Geol. Bull.*, v. 67, No. 1, 1983, pp. 41-69.
- Cominco Ltd. Annual Report. Vancouver, B. C., 1989.

Cominco Ltd. Polaris Mine: Production Success in the Rugged Arctic. Ch. in *Min. Eng., Soc. for Min., Metall., and Expl., Inc.*, Littleton, CO., 1984, pp. 1401-1406.

Connolly, R. E. Overview of Research on the Management of Mining Wastes. Ch. in *Mine Planning and Equip. Selection 1990*, ed. by R. K. Sinhal, and M Varva, Proc. of the 2nd Int. Symp. on Mine Planning and Equip., Selection, Calgary, Canada, Nov. 7-9, 1990, pp. 353-362.

Connor, M. S. Is Statistical Significance Useful in Dredged Material Testing. *Coastal Ocean Pollut. Assess. News, Man and The Mar. Environ.*, v. 2, No. 2, 1982, 21 pp.

Courtain, P. Tailing Disposal. If You Can't Store It, Pump It. *World Min.*, v. 5, No. 5, 1969, pp. 22-27.

Craig, H. A Scavenging Model for Trace Elements in the Deep Sea. *Earth and Planetary Sci. Letters*, v. 23, 1974, pp. 149-159.

Crawford, L. Escondida. *RTZ Review*, v. 17, 1991, pp. 6-8.

Creelius, E. A. Review of the Westgold Monitoring Program. Prepared by Battelle, Pac. Northwest Lab., WA. for Westgold Expl. and Min. Comp., Nome, AK, 1990, 10 pp.

Crickmore, M. J. Tracer Tests of Eddy Diffusion in Field and Model. *Hydraulics Div. Proc. Am. Soc. of Civil Eng.*, v. 98, 1972, pp. 1737-1752.

Cronin, J. L. Photographic Summary of the Near Field Model, Quartz Hill Project, Southeast Alaska. 1984.

Cronin, J. L. Bathymetry of Wilson Arm, Bakewell Arm and Smeaton Bay, Southeast Alaska. 1985.

Crouch, E. A. C., and R. Wilson. *Risk/Benefit Analysis*. Ballinger, Cambridge, 1982, 217 pp.

D'Itri, F. M. *Artificial Reefs; Marine and Freshwater Applications*. Lewis. Chelsea, MI., 1985.

Daly, R. A. Origin of Submarine Canyons. *Am. J. Sci.*, v.31, 1936, pp. 401-420.

Davis, J. P. T. Determination of Slope Failure Mechanisms in a Leveed Sea Floor Valley, Rupert Inlet, B. C. B. A. *Sc. Geol. Eng. UBC*, 1978.

Davis, S. N., and R. J. M. DeWeist. *Hydrogeology*. Wiley, 1966.

Defant, A. *Physical Oceanography*. Pergamon, v. 1, 1961, 729 pp.

Demlow, T., C. Sweeney, N. Shi, M. Robb, and L. Gardner. Nome Offshore Placer Project. Draft Annu. Rep., Prepared by EHSI and ENSR Consulting and Eng., for Westgold Expl. and Min. Comp., Nome, AK, v. II, 1989.

Devuyst, E. A, G. Robbins, R. Verfunst, B. Tandi, and P. F. Iamarino. Inco's Cyanide Removal Technology Working Well. Ch. in *Min. Eng., Soc. for Min. and Expl.*, Littleton, CO., v. 43, No. 2, 1991, pp. 205-207.

Dira, D. C., and A. V. Canete. ACMDC's Tailings Disposal Today. Paper in Sixth Symp. on Miner. Resour. Develop. and the 27th Annu. Mine Safety Conf., 1980.

Doepker, R. D., and P. L. Drake. Laboratory Study of Submerged Metal-Mine Tailings 1: Effect of Solid-Liquid Contact Time and Aeration on Contaminant Concentrations. *Soc. for Min., Metall., and Expl., Inc.*, Littleton, CO, Preprint No. 90-149, 1990, 7 pp.

Doughty, F. T. C. Copper Mining and Extraction at Repparfjord. *Min. Mag.*, v. 132, 1975, p. 31.

Down, C. G. and J. Stocks. Positive Uses of Mill Tailings. *Min. Mag.*, v. 137, No. 9, 1977, pp. 213.

Down, C. G. and J. Stocks. Methods of Tailings Disposal. *Min. Mag.*, v. 136, No. 5, 1977, pp. 345-359.

- Down, C. G., and A. J. B. Mill. Marine Disposal of Mine and Mill Tailings. Ch. in Proc. Xlth Commonwealth Min. and Metall. Congr., Hong Kong, ed. by M. J. Jones, IMM, S. Austin & Sons, Ltd. Hutford, England, v. 139, No. 2, 1978, pp. 421-431.
- Duane, D. B. Sedimentation and Ocean Engineering: Placer Mineral Resources. Coastal Eng. Res. Cent., Fort Belvoir, Virginia.
- Duchrow, R. M., and W. H. Evehart. Turbidity Measurement. Transactions of the Am. Fish. Soc., 100 C4, 1971, pp. 682-690.
- Ebersole, W. C. Predicting Disturbances to the Near and Offshore Sedimentary Regime From Marine Mining. Water, Air, and Soil Pollut., v. 1, 1971, pp. 72-88.
- Eger, P., K. Lapakko, and A. Weir. Heavy Metals Study - 1980. Prog. Rep. on the Field Leaching and Reclamation Program. Minnesota Dep. of Natur. Resour., Div. of Miner., 1981.
- Ehrlich, H. L. The Hydrosphere. Ch. in Geomicrobiol., ed. by H. L. Ehrlich, Marcel Dekker, Inc., 1981, pp. 35-61.
- Ellis, D. V. Marine Tailings Disposal. Ann Arbor Sci., 1988, 368 pp.
- Ellis, D. V. Underwater Mining Institute. Mar. Pollut. Bull., v. 19, No. 12, 1988, p 653.
- Ellis, D. V. The Amax Molybdenum Mine at Kitsault, B. C. and its Marine Tailings Disposal System. Rep. on the Public Mtg. at Prince Rupert, Biol. Dept., Univ. of Victoria, v. 1, 1981.
- Ellis, D. V. The Amax Mine at Kitsault, B. C. and its Marine Tailings Disposal System. Rep. on the Public Mtg. at Vancouver, B. C., v. 2, 1981.
- Ellis, D. V. Canadians Briefed on Deep Sea Mining. Mar. Pollut. Bull., v. 18, No. 2, 1987, p. 63.
- Ellis, D. V. Marine Tailings Disposal. Mar. Pollut. Bull., v. 14, No. 1, 1983.
- Ellis, D. V. Case Histories of Coastal and Marine Mines. Ch. in Chem. and Biol. of Solid Waste, ed. by W. Salomons and U. Forstner, Springer, 1988, pp. 73-100 (305 pp).
- Ellis, D. V. Viewpoint, Kitsault, B. C. - Technical Communication in a Non-Technical World. Mar. Pollut. Bull., v. 13, No. 3, 1982, pp. 78-80.
- Ellis, D. V. Submersible Surveys in the Tailings Receiving Area for Island Copper Mines. University of Victoria Cruise Report, 1983.
- Ellis, D. V. The Need For Exchange of Reclamation Information Between Surface and Marine Mining Operations. Proc. 1986, Natl. Symp. Min. Hydrol. Sediment Reclam., Lexington, KY., 1986, pp. 35-42.
- Ellis, D. V. Interpretation and Evaluation of Transmissometer Surveys Undertaken By Dobrocky Seatech. Ltd. on Behalf of Utah Construction and Mining Co. Ltd. in the Area Adjacent to Island Copper Mine. Rep. Island Copper Mine, 1972, 61 pp.
- Ellis, D. V. Potential Relationship Between Values for Turbidity and Fixed Suspended Solids in the Island Copper Mine Receiving Area. Rep. to Island Copper Mine, 1975.
- Ellis, D. V. Discussion of Sea Outfalls - A Review of Failure, Damage, and Impairment Mechanisms. Proc. Inst. Civ. Engrs. Part 1, v. 80, 1986, pp. 553-554.
- Ellis, D. V. Mining - Island Copper (Canada). Ch. 4 in Environments at Risk, ed. by D. V. Ellis. Case Histories of Impact Assessment, 1989, 329 pp.

Ellis, D. V. et al. Statistical Reconnaissance of Monitoring Data from a Decade of Mine-Derived Turbidity: 1971-1981, Poster Display, Symposium The Dynamics of Turbid Coastal Environments. Bedford Inst. of Oceanogr., Halifax, N.S., Sep. 29 - Oct. 1, 1981, 9 pp.

Ellis, D. V., and A. A. Jones. The Ponar Grab as a Marine Pollution Monitoring Sampler. *Can. Res.*, Jun./Jul. 1980, 1980, p. 23.

Ellis, D. V., and G. C. Jewsbury. Progress Report on Turbidity Analyses in the Island Copper Mine Receiving Area. Rep. to UBC Monitoring Group for ICM, 1974, 46 pp.

Ellis, D. V., and J. L. Littlepage. An Oceanographic Survey of Qaumarujuk and Agfardlikavsá Fjords. Marmorilik W. Greenland, 1972.

Ellis, D. V., and J. L. Littlepage. Marine Discharge of Mine Wastes: Ecosystem Effects and Monitoring Programs. *Can. Min. Metall. Bull.*, v. 65, No.720, 1972, pp. 45-50.

Ellis, D. V., and J. L. Littlepage. Feasibility Study for Marine Disposal of Tailings at the Polaris Mine-Site. Rep. to Cominco, 1974, 320 pp. plus appendices.

Ellis, D. V., and J. L. Littlepage. Re-Assessment of Tailing Disposal to the Sea at the Polaris Mine. Rep. to Cominco, 1975, 18 pp. plus appendices.

Ellis, D. V., and L. A. Taylor. Biological Engineering of Marine Tailing Beds. Ch. in *Environ. Management of Solid Waste*, ed. by W. Salomons and U. Forstner, Springer,, pp. 185-207.

Ellis, D. V., C. A. Pelletier, and A. J. Jordan. Marcopper Marine Tailings Discharge Assessment. Rescan Rep. Marcopper Min. Corp., 1981, 83 pp.

Ellison, T. H., and J. S. Turner. Turbulent Entrainment in Stratified Flows. *J. Fluid Mech.*, v. 6, 1959, pp. 423-448.

Engineering and Mining Journal. Mining in British Columbia Utah Mines Ltd.: A Deepening Pit and Automatic Mill Controls. V. 182, No. 11, 1981, pp. 220-221.

Engineering and Mining Journal. The Far North, Mining Outposts Have Motivated Settlement in Canada's North. V. 182, 1981, pp. 24-225.

ENSR. Supplemental ODCE Information Data Base for Norton Sound 45. Nome Offshore Placer Project. Submitted to US EPA, Region X, WA., 1989.

Environmental Protection Agency (ed.). A BPJ Evaluation Using the Ocean Discharge Criteria for Mill Tailings Disposal From the Proposed Quartz Hill Molybdenum Mine. EPA Work Assignment 8, Reg 10, Seattle, 1988, 168 pp. and appendices.

Evans, J. B. Summary Report, Pre-Operational Phase, March - Sept. 1971. *Environ. Program*, Island Copper Mine, Rupert Inlet, B. C., Univ. of B. C., 1972.

Evans, J. B. and G. W. Poling. Discharging Flotation Mill Tailings into a Coastal Inlet. Pres. at the 77th Annu. Mtg. of the Can. Inst. of Min. and Metall., 1975.

Evans, J. B., D. V. Ellis and C. A. Pelletier. The Establishment and Implementation of a Monitoring Program for Underwater Tailing Disposal in Rupert Inlet, British Columbia. Ch. in *Tailing Disposal Today: Proc. First Int. Tailing Symp.*, ed. by C. L. Aplin and G. O. Argnall, San Francisco, CA: Miller Freeman, 1973, pp. 512-552.

Farmer, D. M. Engineering and Scientific Principles. Ch. in *Mar. Tailings Disposal*, ed. by D. V. Ellis. Ann Arbor, 1982, pp. 183-192.

Farmer, D. M., and H. E. Huppert. The Oceanography of Fjords. *Nature*, v. 280, No. 5720, 1979, pp. 273-274.

- Farmer, D. M., and J. D. Smith. Generation of Lee Waves Over the Sill in Knight Inlet. Ch. in *Fjord Oceanogr.*, ed. by J. F. Freeland, D. M. Farmer and C. D. Levings, Plenum, 1980, pp. 259-269.
- Farmer, D. M., and J. D. Smith. Tidal Interaction of Stratified Flow With A Sill in Knight Inlet. *Deep-Sea Res.*, v. 27A, 1980, pp. 239-254.
- Filion, M. P., and K. Ferguson. Acid Drainage Research in Canada. Pres. at the 29th Annu. General Mtg. of the Can. Inst. of Min. and Metall., Ottawa, Quebec, Canada, May 6-10, Presentation No. 131, 1990, 17 pp.
- Findikakis, A. N. Sedimentation Model Output 100 lbs/cu. ft. Case - Boca de Quadra. Bechtel Civil & Miner., Inc., 1984.
- Findikakis, A. N. Final Run - Tailings Disposal in Boca de Quadra Inlet. Bechtel Civil & Miner., Inc., 1985.
- Findikakis, A. N. Final Run - Wilson Arm/Smeaton Bay. Bechtel Civil & Miner., Inc., 1985.
- Findikakis, A. N. Study of Submarine Tailings Disposal in Wilson Arm/Smeaton Bay. Technical Memorandum. Bechtel Civil & Miner., Inc., 1985.
- Findikakis, A. N. Study of Submarine Tailings Disposal in Boca de Quadra - Appendix A: The Density Current/Sedimentation Mathematical Model. Bechtel Civil & Miner., Inc., 1983.
- Findikakis, A. N., and R. L. Street. Vertical Structure of Internal Modes in Stratified Flows. *J. Eng. Mech. Div., Am. Soc. Civ. Eng.*, v. 108, 1982, pp. 583.
- Findikakis, A. N., and R. L. Street. Finite Element Simulation of Stratified Turbulent Flows. *J. Eng. Mech. Div., Am. Soc. Civ. Eng.*, v. 108, 1982, pp. 904.
- Findikakis, A. N., P. J. Ryan, and J. F. Kerl. A Study of Marine Disposal of Mine Tailings. SME-AIME, Annu. Meet., 1986, 9 pp.
- Fish, R. Mining in Arctic Lands - The Black Angel Experience. *CMJ*, v. 8, 1974, pp. 24-29.
- Fitch, B. Unresolved Problems in Thickener Design and Theory. AIME Centennial Annu. Meeting, NY, NY, Feb. 26-Mar. 04, 1971, 1971.
- Fletcher, A. W. and Z. Mustafa. Progress on the Exploitation of Metalliferous Sediments of the Red Sea. Ch. in *Natl. and Int. Management of Miner. Resour.*, Inst. Min. Metall., 1980, pp. 3-16.
- Frank, R. A. The Promise of Deep Sea Mining. *Min. Cong. J.*, 1978, pp. 73.
- Freeland, H. J., D. M. Farmer, and C. D. Levings (eds.). *Fjord Oceanography. Proc. of 1979 NATO Conf. at Victoria, B.C., Canada. NATO Conf. Series IV, Mar. Sci.*, Plenum, v. 4, 1980, 715 pp.
- Gade, H. G. Deep Water Exchanges in a Sill Fjord: A Stochastic Process. *J. Phys. Oceanogr.*, v. 3, 1973, pp. 213-219.
- Gade, H. G. and A. Edwards. Deep-Water Renewal in Fjords. Ch. in *Fjord Oceanogr.*, ed. by N.J. Freeland, D.M. Farmer, and C.D. Levings, Plenum, 1980, pp. 453-489.
- Gafford, R. D. Automation of Monitoring Equipment for Marine Pollution Studies. Ch. in *Mar. Pollut. and Sea Life*, ed. by M. Ruivo, FAO of the United States, 1973.
- Galay, V. J. Sedimentation in Deltas and River Valleys due to Mine Tailings Disposal. *Coastal Zone Newsletter*, v. 4, No. 1, 1982, pp. 14.
- Garbe, C. W. Disposal Limitations Demand Precise Maintenance Dredged Volumes. *World Dredging Mar. Const.*, v. 14, 1978, pp. 50-52.

Garland, C., and R. Hagerty. Environmental Planning Considerations for Deep Ocean Mining. Pres. at 8th Annu. Conf. and Expos. Mar. Technol. Soc., Applications of Mar. Technol. to Human Needs, 1972, pp. 381-393.

Gee and Carssow. A Thumbnail Sketch of Community Impacts on Ketchikan. Prepared for U. S. Borax and Chemical Corp., Ketchikan, AK., 1981.

Geen, G. Comments on the Preliminary Draft ODCE Quartz Hill Mine Tailings Disposal in Boca de Quadra. Res. Environ. Ltd., 1984.

Geographica. Lake Baikal's Deep Vent: A Freshwater First. v. 175, No. 6, 1990.

Geyer, W. R., and G. A. Cannon. Sill Processes Related to Deep Water Renewal in a Fjord. J. Geophys. Res., v. 87, 1982, pp. 7985.

Gibson, R. B. The Strathcona Sound Mining Project, A Case Study of Decision Making. Sci. Council of Canada, Background Study, No. 42, 1978.

Gijssen, M. Aquaculture and Marine Mineral Development in Canada: Implications for Resource Management. Co-op. Stud. Univ. of Victoria. Special Project for the Ocean Min. Div. Mine. Strat. Branch, Ener. Mines and Res. Can., 1988, 76 pp.

Girgrah, M., and V. K. Shah. Construction of a Deep-Sea Dock in the Arctic. Int. Conf. on Port and Ocean Eng. Under Arctic Conditions, St. John's, Newfoundland (Canada), 1977.

Giselher, G. Observation on Turbulent-Drag Reduction in a Dilute Suspension of Clay in Sea-Water. J. Fluid Mech., v. 75, No. 1, 1976, pp. 29-47.

Glass, G. E., and J. E. Poldoski. Interstitial Water Components and Exchange Across the Water Sediment Interface of Western Lake Superior. Verh. Int. Verein. Limnol., v. 19, 1975, pp. 405-420.

Golder Associates. 1981 Report of Environmental Geohydrology Studies, Quartz Hill Project. Bellevue, WA, D217, 1982, pp. 813-1202.

Golder Associates. 1982 Report of Geohydrology Studies, Quartz Hill Project. Bellevue, WA, D-243B, 1983, pp. 813-1202.

Golder Associates. 1983 Report of Geohydrology Studies, Quartz Hill Project. D-284, 1983, pp. 813-1202.

Gowans, J. The Polaris Concentrator. CIM., 84th Annu. Gen. Mtg., Quebec City, 1982.

Green, D. W. An Investigation of the Disposal of Micaceous Residue Through a Sea Outfall. Inst. Civil Eng. Proc., v. 53, No. 2, 1972, pp. 127-149.

Greenland Government Report. Black Angel Pre-Discharge Rep., 1973.

Grimwood, C., and T. J. McGhee. Prediction of Pollutant Release Resulting from Dredging. J. Water Pollut. Control Fed., v. 51, No. 7, 1979, pp. 1811-1815.

Gross, G. A., and C. R. McLeod. Metallic Minerals on the Deep Seabed. Geol. Surv. Canada Paper 86-21,, 65 pp.

Gross, G. G. Mineral Deposits on the Deep Seabed. Mar. Min., v. 6, 1987, pp. 109-119.

Guarino, C. F., M. D. Nelson, and S. S. Almeida. Ocean Dispersal as an Ultimate Disposal Method. J. Water Pollut. Control Fed., v. 51, No. 4, 1979, pp. 10.

Haig, and L. D. Smillie. Seawater Flotation. Can. Min. J., v. 95, 1974, pp. 68-70.

Hans, N. C., D. E. Pierce, K. W. Leong, and F. H. Wang. Mercury Distribution in Ancient and Modern Sediment of Northeastern Bering Sea. Mar. Geol., v. 18, 1975, pp. 91-104.

- Hansen, J., and E. Somer. Marine Disposal of Heavy Suspensions. Kem-Tek 2 Cong., Chem. Abstr., v. 7, No. 2, 1971, pp. 1-12.
- Harding, L. Use of Fjords for Disposal of Mine Tailings. Coastal zone 83. Paper in Proc. 3rd Symp. Coastal and Ocean Management, San Diego, v. 1, 1983, pp. 32-51.
- Hart, T. L. Tools for Effective Management of Disposal of Dredged Material in an Ocean Environment. Ch. in Waste Disposal in the Oceans, Minimizing Impact, Maximizing Benefits, ed. by D. F. Soule, and D. Walsh, Westview, Boulder, CO., 1983.
- Hartley, A. C. Weathering Studies of Bougainville Mine Tailings in Lysimeters. Aust. Journ. Soil Res., v. 17, 1979, pp. 355-360.
- Hassett, N. J. Thickening in Theory and Practice. Min. Sci. Eng., v. 1, 1969, pp. 24-40.
- Hawley, J. R. On Land or Under Water? The Tailings Disposal Problem. Ministry of the Environ., Toronto, Canada, 1975.
- Hay, A. E. The Effects of Submarine Channels on Mine Tailing Disposal on Rupert Inlet, B.C. Ch. in Mar. Tailing Disposal, ed. by D. V. Ellis, Ann Arbor Sci., 1982, pp. 139-182.
- Hay, A. E. Turbidity and Deep-Water Exchange in Rupert- Holberg Inlets, 1973-1976. Ch. in Sum. Rep., Fifth Production Year: Oct. 1975- Sep. 1976, ed. by J. B. Evans, 1978.
- Hay, A. E. Submarine Channel Formation and Acoustic Remote Sensing of Suspended Sediments and Turbidity Currents in Rupert Inlet, B. C. Ph. D. Thesis, Univ. of British Columbia, Vancouver, 1981.
- Hay, A. E. On the Remote Acoustic Detection of Suspended Sediment at Long Wavelengths. J. of Geophys. Res. C. Oceans, v. 88, No. 12, 1983, pp. 7525-7542.
- Hay, A. E., J. W. Murray, and R. W. Burling. Submarine Channels in Rupert Inlet, British Columbia: II. Sediments and Sedimentary Structures. Sed. Geol., v. 36, 1983, pp. 317-339.
- Hay, A. E., J. W. Murray, and R. W. Burling. Submarine Channels in Rupert Inlet, British Columbia: I. Morphology. Sed. Geol., v. 36, 1983, pp. 289-315.
- Hay, A. E., R. W. Burling, and J. W. Murray. Remote Acoustic Detection of a Turbidity Current Surge. Science, v. 217, 1982, pp. 833-835.
- Hayashi, T., and M. Ito. Diffusion of Effluent Discharging Vertically into Stagnant Seawater. Coastal Eng. in Jpn., v. 17, 1974, pp. 199-213.
- Hayter, E. J., and A. J. Mehta. Modeling Fine Sediment Transport in Estuaries. EPA-600/S3-83-045, 1983.
- Heggie, D. T. and D. C. Burrell. Deep Water Renewals and Oxygen Consumption in an Alaskan Fjord. Estuarine, Coastal and Shelf Sci., v. 13, 1981, pp. 83-99.
- Henrickson, J. J., H. Haar, and F. B. Pedersen. Sediment Laden Buoyancy Jets. Prog. Rep. Inst. Hydrodyn. and Hydraulic Eng. Tech. Univ. Denmark, v. 57, 1982, pp. 33-42.
- Henry, G. R. W. Neal, and S. H. Greene. Laboratory Investigation of the Dynamics of Mud Flows Generated by Open-Water Pipeline Disposal Operations. Tech. Rep. D-78-46, U. S. Army Eng. Waterways Experiment Station, Vicksburg, MS., 1978.
- Herbich, J. B. Proceedings of the 11th Dredging Seminar. Texas A&M Univ., College Station., Cent. for Dredging Studies. TAMUSG-80-103; CDS-219, 1979.
- Hillis, R. From Seafloor to Hilltop: Land and Marine Reclamation at Island Copper. Proc. 8th Annu. British Columbia Mine Reclamation Symp., Victoria, British Columbia, 1984.

- Hillis, R. and I. Horne. Land and Marine Wastedumps. Proc. 8th Annu. British Columbia Mine Reclamation Symp., Victoria, British Columbia, 1984.
- Hillis, R. J. Cyanide in Island Copper Effluents. ECM Rep., 1982.
- Hoff, J. T., J. A. J. Thompson, and C. S. Wong. Heavy Metal Release from Mine Tailings into Seawater - a Laboratory Study. Mar. Pollut. Bull., v. 13, No. 8, 1982, pp. 283-286.
- Holliday, B. W. Processes Affecting the Fate of Dredged Material. Tech. Rep. DS-78-2, U.S. Army Eng. Waterways Experiment Station, Vicksburg, MS., 1978.
- Holliday, B. W., B. H. Johnson, and W. A. Thomas. Predicting and Monitoring Dredge Material Movement. Tech. Rep. DS-78-3, U.S. Army Eng. Waterways Experiment Station, Vicksburg, MS., 1978.
- Holme, N. A. Disposal of China Clay Waste in the English Channel. Mem. Bureau Recher. Geolog. Minieres (France), v. 79, 1972, pp. 269-270.
- Holme, N. A., and P. K. Probert. Disposal of Solid Waste in the Marine Environment With Particular Reference to the China Clay Industry. Ch. in Environ. Management of Miner. Wastes, ed. by G. T. Goodman and M. J. Chadwick, Sijthoff & Nordhoff, 1978, pp. 239-253.
- Holtedahl, H. Recent Turbidities in the Hardangerfjord, Norway. Ch. in Submarine Geol. and Geophys., ed. by W. F. Wittard, and R. Bradshaw, 17th Symp. Colton Res. Soc., Butterworths, London, 1965, pp. 107-140.
- Hong, G. I. Sedimentation Dynamics in Boca de Quadra Fjord, Southeast Alaska. Rep. U.S. Borax, 1984, 17 pp.
- Hylleberg, J. Temporal Changes in Sediment Characteristics on the West Coast of Phuket Island. Phuket Mar. Biol. Cent. Res. Bull., v. 37, 1985.
- Ichiye, T. Turbulent Diffusion of Suspended Particles Near the Ocean Bottom. Deep-Sea Res., v. 13, No. 4, 1966, pp. 679-685.
- Ichiye, T., and M. Carnes. Modeling of Sediment Dispersion During Deep Ocean Mining Operations. Proc., 9th Ann. Offshore Technol. Conf., v. 1, 1977, pp. 421-432.
- Ichiye, T., M. Inoue, and M. Carnes. Horizontal Diffusion in Ocean Dumping Experiments. Ch. in Ocean Dumping of Ind. Wastes, ed. by B. H. Ketchum, D. R. Kester, and P. K. Park, Mar. Sci., v. 12.
- ICM. Island Copper Mine. Western Miner, 1974, 11 pp.
- ICM. Closure Plan (Draft) Island Copper Mine. BHP - Utah Minerals Int., 1990.
- IECO. Geotechnical Investigations For Mine Support Facilities. Quartz Hill Molybdenum Project. Tech. Rep. U. S. Borax and Chem. Corp., v. 1, 1981.
- Institution of Civil Engineers, London. Coastal Discharges, Engineering Aspects and Experience. Proc. Conf., 1980.
- Inter-Governmental Pollution Consultative Organization. Scientific Criteria For the Selection of Waste Disposal Sites at Sea/IMCO/FAO/UNESCO/WMO/WHO/IAEA/UN/UNEP, Joint Group of Experts on the Scientific Aspects of Marine Pollution. (GESAMP), 1982, 60 pp.
- International Tailing Symposium, 1st. Tailing Disposal Today: Proceedings. Tucson, AR., Miller Freeman, 1972, 861 pp.
- Island Copper Mine. A Study of the Suspended Sediment Movement Through Quatsino Narrows. Environ. Dep. Island Copper Mine, 1980, 44 pp.
- Jain, S. C. and J. F. Kennedy. Near-Field Model Study of Mine-Tailings Discharge into a Fjord. Inst. of Hydraul. Res., Univ. of IA., 1984.

- Jain, S. C., and J. F. Kennedy. Sediment-laden Circular Wall-jet. Proc. 21st IAHR Conf., Melbourne, Australia, 1985.
- Jewett, S. C., L. A. Gardner, C. King, T. Richardson, C. Sweeney, C. Rieg, and T. Demlow. Nome Offshore Placer Project: Annual Report 1989. Prepared by ENSR Consult. and Eng. (Doc. No. 7235-007) for Westgold Expl. Min. Comp., Nome, AK., 1990, 178 pp.
- Jewett, S. C., L. A. Gardner, C. Richardson, G. Malinky, A. Hartshorn, J. Moore, P. C. Garvin, and C. E. Sweeney. Nome Offshore Placer Project Final Annual Report 1990. ENSR For Western Gold Expl. Min. Co., 1991, 500 pp.
- Jewett, S. L. Gardner, and P. Athey. Nome Offshore Placer Project: Annual Report, 1988. Prepared by ENSR Consul. and Eng., for Westgold Expl. and Min. Comp., Nome, AK., v. I, 1989, 216 pp.
- Johnson, B. H., and B. W. Holliday. Evaluation and Calibration of the Tetra Tech. Dredged Material Disposal Models Based on Field Data. Tech. Rep. DS-78-47, U.S. ARMY Eng. Waterways Experiment Station, Vicksburg, MS., 1978.
- Johnson, J., and V. T. McCauley. Technical Requirements for Control of Ocean Dumping, Applications of Marine Technology to Human Needs. Reprints 8th Annu. Conf. & Expos. Mar. Tech. Soc., 1972, pp. 753-761.
- Johnson, R. D. Dispersal of Recent Sediments and Mine Tailing in a Shallow-silled Fjord, Rupert Inlet, British Columbia. Ph.D. Thesis, Univ. of British Columbia, Vancouver, 1974.
- Jones & Stokes Associates, Inc. Draft, BPJ of Tailings Disposal. 1986.
- Jones & Stokes Associates, Inc. Final, Quartz Hill Physical Oceanographic Analyses. USEPA, 1988.
- Jones & Stokes Associates, Inc. Final, A BPJ Evaluation Using the Ocean Discharge Criteria for Mill Tailings Disposal. EPA Works Assign., No. 8.
- Kessler, T. A. Mixing-Primary Production Coupling in Holberg Inlet, A Tidally Energetic Fjord. PhD Thesis, Univ. B. C., 1986.
- Kihlstedt, P. G. Waste Water in Metal Mining Industries. Pres. at Int. Cong. on Ind. Waste Water, Stockholm, 1970.
- Klemas, V., D. Maurer, W. Leatham, P. Kinner, and W. Treasure. Dye and Drogue Studies of Spoil Disposal and Oil Dispersion. J. Water Pollut. Control Fed., v. 46, No. 8, 1974, pp. 2026-2034.
- Klinck, J. M., J. J. O'Brien, and H. Svendsen. A Simple Model of Fjord and Coastal Circulation Interaction. J. Phys. Oceanogr., v. 11, 1982, pp. 1612-1626.
- Klohn, E. J., and D. Dingeman. Tailings Disposal System for Reserve Mining Company. Ch. in Tailing Disposal Today, V 2: Proc. Int. Tailing Symp., 2nd, Denver. Co., May 21-25, 1978, Miller Freeman, 1979, pp. 178-209.
- Koh, R. C. Y., and N. H. Brooks. Fluid Mechanics of Waste Water Disposal in the Ocean. Annu. Rev. of Fluid Mech., v. 7,, pp. 187-211.
- Kolpack, R. L., B. J. Balcom, N. W. Phillips, G. N. Bigham, and R. Barrick. Processes Influencing the Long-Term Fate of Drilling-Solids Discharges Off California. Fifth Int. Ocean Disp. Symp., Corvallis, OR., 1984.
- Komar, P. D. Beach Processes and Sedimentation. Prentice-Hall, 1976.
- Kowalik, and Findikakis. The Numerical Modeling of Fjord Circulation and Submarine Disposal of Mine Tailings in Wilson Arm/Smeaton Bay, Southeast Alaska. Bechtel Civil & Miner., Inc., 1985.
- Kowalik, Z. Numerical Modeling of Fjord Circulation and Submarine Disposal of Mine Tailings in Boca de Quadra, Southeast Alaska. Final Rep., Univ. of AK., 1984.
- Kowalik, Z., and D. L. Nebert. Seasonal Circulation in a Deep Fjord; Smeaton Bay, Alaska. Estuarine Coastal and Shelf Sci., (Submitted for Publ.), 1983.

- Kranck, K. Flocculation of Suspended Sediment in the Sea. *Nature*, v. 246, No. 5432, 1973, pp. 348-350.
- Kranck, K. The Role of Flocculation in the Transport of Particulate Pollutants in the Marine Environment. *Proc. Int. Conf. Trans. Persist. Chem. Aquat. Eco-Systems*, Ottawa, Can., I-41-46, 1974.
- Kranck, K. Sedimentation Processes in the Sea. Ch. in *The Handbook of Environ. Chem.*, ed. by O. Hutzinger, Springer, v. 2, Part A, 1980, pp. 61-75.
- Kranck, K. Sediment Deposition from Flocculated Suspensions. *Sedimentology*, v. 22, 1975, pp. 111-123.
- Kraul, D. P. Deep Water Flow and Exchange Processes in Alice Arm, B. C. Contractor Rep. Ser. 81-4, Inst. of Ocean Serv., Sidney, B. C., 1981.
- Krishnappan, B. G. Dispersion of Dredged Spoil When Dumped as a Slug in Deep Water. *Proc. 1st Int. Symp. Dredging Technol.*, D2-13 D2-32, British Hydromech. Res. Assoc., 1975.
- Kuenen, Ph., H. and C. I. Migliorini. Turbidity Currents as a Cause of Graded Bedding. *J. Geol.*, v. 58, 1950, pp. 1-127.
- Kuit, W. J. The Polaris Mine Tailings Disposal in the High Arctic. *Pres. at the Mar. Tailings Disposal Symp.*, Ketchikan, AK, 1982.
- Kussat, R. H., M. Jones, and B. Lawley. A Cursory Evaluation of the Deep Lake Tailings Disposal System at Cominco's Benson Lake Operation. *Manu. Rep., Fish. Serv., Vancouver, B. C.*, 1972, p. 1.
- Larsen, V. J., and H. H. Schierup. The Use of Straw for Removal of Heavy Metals from Waste Water. *J. Environ. Qual.*, v. 10, No. 2, 1981, pp. 188-193.
- Laskowski-Hoke, R. A., and B. L. Prater. Dredged Material Evaluations: Correlations Between Chemical and Biological Evaluation Procedures. *J. Water Pollut. Center Fed.*, v. 53, No. 7, 1981, p. 1260.
- Laskowski-Hoke, R. A., and B. L. Prater. Discussion of : Dredged Material Evaluations: Correlations Between Chemical and Biological Evaluation Procedures. *J. Water Pollut. Center Fed.*, v. 54, No. 4, 1982, pp. 406-409.
- Lechich, A. F., F. J. Roethel. Marine Disposal of Stabilized Metal Processing Waste. *J. Water Pollut. Cont. Fed.*, v. 60, No. 1, 1988, pp. 93-99.
- Lewis, E. L., and R. G. Perkins. Seasonal Mixing Processes in an Arctic Fjord System. *J. Phys. Oceanogr.*, v. 12, 1982, pp. 74.
- Lewis, T. Bottom Water Temperature Variations as Observed, and as Recorded in the Bottom Sediments, Alice Arm and Douglas Channel, British Columbia. *Can. Tech. Rep. Hydrog. Ocean Sci.*, v. 18, 1983, pp. 138-161.
- Lillehagen, N. B. Bauxite Mining by Nabalco Pty. Ltd. at Gove, N.T. Ch. in *Min. & Metall. Practices in Australia*, ed. by J.T. Woodcock. The Australasian Inst. of Min. & Metall., Victoria, Australia, 1980, pp. 371-373.
- Littlepage, J. L., D. V. Ellis, R. W. Drinnan, and J. J. Dobrocky. Distribution of Mine and Mill-Tailings in a Marine Inlet; and a Comparison of Methods of Measurement. *Submission to Public Inquiry into Waste Discharges from Mining, Mine-Milling and Smelting*, 1972.
- Littlepage, J. L., D. V. Ellis, and J. Mcinerney. Marine Disposal of Mine Tailing. *Mar. Pollut. Bull.*, v. 15, No. 7, 1984, pp. 242-244.
- Loehr, L. C., and E. E. Collias. A Review of Water Characteristics of Grays Harbor 1938-1979 and An Evaluation of Possible Effects of the Widening and Deepening Project Upon Present Water Characteristics. *Dep. of Oceanogr., Univ. of WA., Prepared for Seattle Distr., U. S. Army Corps of Eng., Seattle, WA.*, 1981.
- Luternauer, J. L., and J. W. Murray. Late Quaternary Morphologic Development and Sedimentation, Central British Columbia Continental Shelf. *Geol. Surv. of Canada, Paper 83-21*, 1983.

- Lutjen, G. P. The Curious Case of the Puerto Rican Copper Mines. *Eng. Min. J.*, v. 172, No. 74, 1971.
- Lutjen, G. P. Tailings Removal Project Opens New Horizons for Reslurrying Process. *Eng. Min. J.*, v. 174, No. 1, 1973, pp. 78-79.
- MacDonald, R. W. The Distribution and Dynamics of Suspended Particles in the Kitimat Fjord System. Ch. in *Can. Tech. Rep. Hydrog. Ocean Sci.*, ed. by R. W. MacDonald, No. 18, 1983, pp. 116-137.
- Magoon, O. T., and H. Conversses. Coastal Zone '83. Proc. Third Symp. on Coastal and Ocean Management, San Diego, CA., Jun. 1-4, 1983.
- Maltby, P. D. R. Worldwide Industrial Application of Mineral Processing Technology. Proc. XIV Int. Min. Proc. Congr., Toronto, Ontario, Canada, Oct. 17-23, 1982.
- Mamen, C. Island Copper - Ecology Wise. *Can. Min. J.*, v. 94, 1973, pp. 31-33.
- Mathews, H. Physical and Geological Aspects of Artificial Reef Site Selection. Ch. 4 in *Artificial Reefs, Mar. and Fresh Water Applications*, ed. by F. M. D'Itri. Lewis. Chelsea. MI., 1985, pp. 141-148.
- Mathews, J. B. The Seasonal Circulation of the Glacier Bay, Alaska Fjord System. *Estuarine, Coastal and Shelf Sci.*, v. 12, 1981, pp. 679-700.
- Mathiesen, B., E. Tesaker, and K. Pedersen. Deaeration of Tailing Slurry During Disposal. Int. Conf. Hydraulic Modelling of Civil Eng. Structures, Coventry, England, 1982.
- Matthews, C. W. Graphs Simplify Determination of Launder Size and Slope. *Eng. Min. J.*, v. 165, 1964, pp. 176-179.
- McElvain, R. and I. N. D. Cave. Transportation of Tailings. No J. Ref.,.
- McGregor, B. A., and M. N. D. Lockwood. Mapping and Research in the Exclusive Economic Zone. NOAA/U. S. Geol. Surv., 40 pp.
- Menard, H. W. Deep-sea Channels, Topography and Sedimentation. *Bull. Am. Assoc. Petroleum Geol.*, v. 40, 1955, pp. 2195-2210.
- Metcalf and Eddy, Inc. *Wastewater Engineering: Treatment, Disposal, Reuse*. 2nd ed. McGraw-Hill, 1979.
- Middleton, G. U. Experiments on Density & Turbidity Currents 3, Deposition of Sediment. *Can. J. Earth Sci.*, v. 4, 1967, pp. 475-505.
- Middleton, G. U. Experiments on Density and Turbidity Currents 2. Uniform Flow of Density Currents. *Can. J. Earth Sci.*, v. 3, 1966, pp. 627-637.
- Mining Magazine. Marine Disposal. v. 2, 1977.
- Mining Magazine. Moves Towards Development of Cerro Colorado, Panama. v. 144, No. 6, 1981, 433 pp.
- Mining Magazine. Rana Gruber: New Pits, New Plant. v. 143, 1980, 386 pp.
- Mining, Engineering Publishers. Bougainville - The Establishment of a Copper Mine. Construction, St. Kilda, Australia, 1973.
- Ministry of Mines and Petroleum Resources. Guidelines for the Design, Construction, Operation, and Abandonment of Tailings Impoundments, British Columbia. Province of B. C., 1978, 5 pp.
- MMC. Annual Reports. Malaysian Min. Corp.,.
- Moller, J. S. Hydrodynamics of an Arctic Fjord. *Inst. Hydrodyn. Hydr. Eng., Tech. Univ., Denmark, Ser. Paper 34*, 1984, 197 pp.

Moore, J. R., and C. J. Welkie. Metal-bearing Sediments of Economic Interest, Coastal Bering Sea. Proc. Symp. Sedimentation AK. Geol. Soc., K1-17, 1976.

Moore, J. W. Distribution and Transport of Heavy Metals in the Sediments of a Small Northern Eutrophic Lake. Bull. Environ. Contam. Toxicol., v. 24, No. 6, 1980.

Moore, J. W. Influence of Water Movements and Other Factors on Distribution and Transport of Heavy Metals in a Shallow Bay (Canada). Arch. Environ. Contam. Toxicol., v. 10, 1981, pp. 715-724.

Morgan, C. L., and F. T. Lovorn. Modeling the Coagulation of a Solid Waste Discharge from a Manganese Nodule Processing Plant. Pre-Print, Wastes in the Ocean: Deep-Sea Waste Disposal, Wiley.

Mustafa, Z., and H. M. Amann. The Red Sea Pre-Pilot Mining Test 1979. Proc. 12th Annu. Offshore Technol. Conf., Paper OTC 3874, v. 4, 1980, pp. 197-210.

Nanisivik Mines Ltd. Annual Reports. Rep. to NWR Water Board, Licence No. N5L3-0159,.

Narayanan, S. Kitimat Physical Oceanographic Study 1977-1978, Tidal Circulation Model. Dobrocky Seatech Ltd., Victoria, B. C., Prepared for Inst. of Ocean Sci., Sidney, B. C., 1979.

NATO Fjord Workshop. Fjord Oceanographic Workshop. Abstr. and Program, Victoria, Canada, Jun. 4-8, 1979.

Nawab Z. A. Red Sea Mining; A New Era. Deep Sea Res., v. 31, No. 6-8A, 1984, pp. 813-822.

Neal, R. W., G. Henry, and S. H. Greene. Evaluation of the Submerged Discharge of Dredged Material Slurry During Pipeline Dredge Operations. U. S. Army Waterways Experiment Station, Vicksburg, MS., A Tech. Rep., 1978.

Nebert, D. L. Physical Oceanography of Boca de Quadra. Tech. Memo., Univ. of AK, Fairbanks, 1983.

Nebert, D. L. Physical Oceanography of Boca de Quadra, 1983 Year End Report. . Inst. of Mar. Sci., Univ. of AK, 1984.

Nebert, D. L. The Circulation of Smeaton Bay and Boca de Quadra Fjord Systems. Ch. in Mar. Tailings Disposal, ed. by D. V. Ellis. Ann Arbor Sci., 1982.

Nebert, D. L. The Physical Oceanography of Smeaton Bay/Wilson Arm. Mar. Environ. Studies in Boca de Quadra and Smeaton Bay, Sum. Rep. Inst. of Mar. Sci., Univ. of AK, 1985.

Nelson, D. D. Sediment Dispersal by Cascading Coastal Water. Geol. Soc. Am., Abstr. Progr., v. 5, 1973, pp. 423-424.

New Scientist. Guyana's Gold Diggers Dredge up Trouble. V. 1742, 1990, p. 17.

Nichols, M. M., G. S. Thompson, and R. W. Faas. A Field Study of Fluid Mud Dredged Material: Its Physical Nature and Dispersal. Tech. Rep. D-78-40, U. S. Army Eng. Experiment Station, Vicksburg, MS., 1978.

Nichols, M., R. Harris, G. Thompson, and B. Nelson. Fate, Transport, and Transformation of Toxics: Significance of Suspended Sediment and Fluid Mud. EPA-600/S3-82-089, 1983.

Nicholson, D. E. Laboratory Analysis of Settling Rates and Development of Simulated Waste Materials. U. S. Dept. Inter. BuMines, Spokane Min. Res. Cent., E. Contract/Grant No: L-98-I,.

Nielsen T. K., and N-E. O. Hansen. Mixing and Exchange Processes in a Small Greenland Sill-Fjord. Ch. in Fjord Oceanogr., ed. by H. J. Freeland, D. M. Farmer, and C. D. Levings, Plenum, 1979, pp. 219-226.

Nielson, J. H. The Three-dimensional Steady Spread of a Density Current Down and Inclined Slope. Basic Res. Prog. Rep. 22, Hydraulics Lab. Tech. Univ. Denmark, 1971.

- Niiler, P. P. and E. B. Kraus. One-dimensional Models of the Upper Ocean. Ch. in *Modelling and Prediction of the Upper Layers of the Ocean*, ed. by E.B. Krays, Pergamon, 1977, pp. 143-172.
- Noche, D. M. A Preliminary Analysis of the Noche-Paracale Offshore Gold Placer Prospect at Paracale, Camarines Norte, Philippines. Prepared for the Environ. Management Bureau, Metro Manila, Philippines, 1989, 9 pp & Maps.
- Normark, W. R. Observed Parameters for Turbidity-Current Flow in Channels, Reserve Fan, Lake Superior. *J. of Sediment. Petrol.*, v. 59, No. 3, 1989, pp. 423-431.
- Normark, W. R. and F. H. Dickson. Man-Made Turbidity Currents in Lake Superior. *Sedimentology*, v. 23, 1976, pp. 815-831.
- Northern Technical Services. ODCE Information Data Base for Norton Sound 45, Nome Gold Project. Submitted to USEPA, Reg. X, Seattle, WA., 1985, 110 pp.
- Northern Technical Services Inc. ODCE Information Data Base Supplemental Report for Norton Sound 45, Nome Gold Project (AK 004319-2). Submitted to USEPA, Reg. C Seattle, WA., 1986, 68 pp.
- Oakley, H. R. Site Investigation and Selection—Hydrographic Aspects. *Proc. Conf., Inst. of Civil Eng., London*, 1980.
- Oliver, D. Aspects of Modernization in Bougainville, Papua New Guinea. *Pac. Islands Stud. Work Pap., Univ. HI., Manoa*, 1981, 91 pp.
- Omo, N. D. Offshore Mining Organization. Bangkok., 26 pp.
- Owen, M. W. A Detailed Study of the Settling Velocities of and Estuary Mud. Rep. No. INT 8, Hydraul. Res. Station, Wallingford, Berkshire, England.
- Packer, T. Survey of Foreign Development Activities for Offshore Non-Fuel Mineral Resources: Part II. Co-op Student, Univ. Waterloo. Special Project for Ocean and Min. Div., Energy, Mines and Res. Can., 1988, 105 pp.
- Palmer, H. D., and M. G. Gross. Ocean Dumping and Marine Pollution: Geological Aspects of Waste Disposal. 51st Annu. Mtg. Soc. Econ. Paleontol. & Mineral., Washington, D.C., 1977.
- Parks, J. M., R. N. Weisman, and A. G. Collins. Fluidization Applied to Sediment Transport (Fast as an Alternative to Maintenance Dredging of Navigation Channels in Tidal Inlets). Ch. in *Waste in the Ocean, Dredged-Mater. Disposal in the Ocean*, ed. by D. R. Kester, B. H. Ketchum, I. W. Duedall, and P. K. Park, Wiley, 1983, pp. 253-273.
- Parsons, T. Review of Ocean Discharge Criteria Evaluation: Quartz Hill Mine Tailings Disposal in Boca De Quadra. Rep. to U. S. Borax, 1985, 26 pp.
- Parsons, T. R., R. I. Perry, E. D. Nutbrown, W. Hsieh, and C. M. Lalli. Frontal Zone Analysis at the Mouth of Saanich Inlet, British Columbia, Canada. *Mar. Biol.*, v. 73, 1983, pp. 1-5.
- Parsons, T. R., T. A. Kessler, and L. Guanguo. An Ecosystem Model Analysis of the Effect of Mine Tailings on the Euphotic Zone of a Pelagic Ecosystem. *Acta. Oceanol. Sinica*, v. 5, No. 3, 1986, pp. 425-436.
- Partizans. Papua New Guinea. Briefing Sheet for the 1990 AGM of RTZ, 1990, 2 pp.
- Pasho, D. W. The United Kingdom Offshore Aggregate Industry: A Review of Management Practices and Issues. COGLA, Ener. Mines and Res. Can., 1986, 32 pp.
- Paulsen, J. C. Selected References for Marine Sedimentation in Boca de Quadra and Wilson Arm/Smeaton Bay Fjords. Southeast Alaska. 1985.
- Pedersen, F. B. On Entrainment in Two Layer Stratified Flow, With Special Focus on an Arctic Sill-Fjord. Pres. at Coastal Oceanogr. Workshop, Oslo, Norway, 1982.

Pedersen, F. B. A Monograph on Turbulent Entrainment and Friction in Two-Layer Stratified Flow. Ser. Paper 25, Inst. of Hydrodyn. and Hydraul. Eng., Tech. Univ. of Denmark, Lyngby, 1980.

Pedersen, F. B. Dense Bottom Currents in Rotating Ocean. J. Hydraul. Div., ASCE, v. 106, No. HY8, 1980, pp. 1291-1308.

Pedersen, F. B. A Brief Review of Present Theories of Fjord Dynamics. Ch. in Hydrodyn. of Estuaries and Fjords, ed. by J. Nihoul, and C. J., Elsevier Sci., 1978.

Pedersen, F. B., J. Fredse, and G. Larnaes. Greenex A/S, Marmorilik, Tailing Outlet, Hydraulic Investigations. LIC, Consulting Eng., Copenhagen, Denmark, 1982.

Pedersen, S. D., and N. Nyholm. Surveying and Mathematical Modelling of Heavy Metal Pollution in an Arctic Fjord System. Int. Conf. on Management & Control of Heavy Metals in the Environ., London, 1979, pp. 333-340.

Pelletier, C. A. Marine Tailings Disposal at Island Copper Mine, Rupert Inlet, B. C. CIM, 79th Gen. Mtg., Ottawa, Can., 1977.

Pequegnat, E. W. Procedural Guide For Designation Surveys of Ocean Dredged Material Disposal Sites. Environ. Lab., U. S. Army Eng. Waterways Experiment Station, NTIS, v. XVIII, No. 268, 1981, 26 pp.

Perkin, R. G., and E. L. Lewis. Mixing in an Arctic Fjord. J. of Phys. Oceanogr., v. 8, No. 5, 1978, pp. 873-880.

Peterson, J. M. Estimating an Effluent Charge: The Reserve Mining Case. Land Economics, v. 53, No. 3, 1977, pp. 328.

Peterson, S. A., and K. K. Randolph. Management of Bottom Sediments Containing Toxic Substances. Proc. 2nd U. S. Japan Experts' Mtg., Oct., 1976, Tokyo, Japan, EPA-600/3-77-083, 1977.

Peterson, S. A., and K. K. Randolph. Management of Bottom Sediments Containing Toxic Substances. Proc. 3rd U. S. Japan Experts' Mtg., Easton, Maryland, Nov., 1977, EPA-600/3-78-084, 1978.

Petrie, L., and N. Holman. Pisces IV Submersible Dives 1973-1982. Dep. Environ., EPS Pac. Reg. Reg. Programme Rep. 83-20, 1983.

Petters, R. A., and F. H. Brockett. Application of Ocean Mining Technology to the Recovery of Mill Tailings in Deep Water. Mar. Min., v. 5, No. 1, 1984, pp. 75-86.

Phillips, J. D., A. H. Driscoll, K. R. Peal, W. M. Marquet, and D. M. Owen. A New Undersea Geological Survey Tool: Argus. Deep-Sea Res., v. 26, No. 2A, 1979, pp. 211-225.

Phillips, O. M. On Turbulent Convection Currents and the Circulation of the Red Sea. Deep-Sea Res., v. 13, 1966, pp. 1149-1160.

Pickard, G. L. Oceanographic Characteristics of Inlets of Vancouver Island, British Columbia. J. Fish Res. Bd. Can., v. 20, No. 5, 1963, pp. 1109-1144.

Pickard, G. L. Annual and Longer Term Variations of Deep Water Properties in the Coastal Waters of Southern British Columbia. J. Fish. Res. Bd. Can., v. 32, No. 9, 1975, pp. 1516-1587.

Pickard, G. L. Oceanographic Features of Inlets in the British Mainland Coast. J. Fish. Res. Bd. Can., v. 18, No. 6, 1961, pp. 907-999.

Pickard, G. L. Some Oceanographic Characteristics of the Larger Inlets of Southeast Alaska. J. Fish. Res. Bd. Can., v. 24, No. 7, 1967, 1475 pp.

Pickard, G. L. and B. R. Stanton. Pacific Fjords: A Review of Their Water Characteristics. Rep., Dep. of Oceanogr., Univ. of B.C., No. 34, 1979.

- Pilkington, E. S., and L. J. Warren. Determination of Heavy-Metal Distribution in Marine Sediments. *Environ. Sci., Tech.*, v. 13, No. 3, 1979, pp. 295.
- Pintz W. S. Ok Tedi. Evolution of a Third World Mining Project. Min. J. Books, London, 1984, 206 pp.
- Plumb, R. H., Jr. The Impact of Taconite Tailings on Dissolved Solid Concentrations in Lake Superior. Proc. Int. Symp., Sep. 6-10, 1981, Interactions Between Sediments & Freshwater, ed. by H.L. Golterman, Junk, B.V. Pub. The Hague, 1977.
- PMC. Tin Mining in Malaysia. Tin Industry Board, 1984, 71 pp.
- PMC. Malaysian Tin. J. Tin Industry Bd., Malaysia,.
- Poling, G. Session 10 Round Table Seminar Submarine and Lake Disposal of Mill Tailing. Proc. 14th Int. Miner. Processing Congr., Toronto, 1982.
- Poling, G. W. Characteristics of Mill Tailings and Their Behavior in Marine Environments. Ch. 2 in *Mar. Tailings Disposal*, ed. by D. V. Ellis, Ann Arbor Sci., 1982, pp. 63-84 (368 pp.).
- Poling, G. W. Sedimentation of Mill Tailings in Freshwater and in Seawater. *CIM Bull.*, v. 66, No. 736, 1973, pp. 97-102.
- Poling, G. W., and V. J. Revnetsev. Round Table Seminar on Submarine and Lake Disposal of Mill Tailing. XIV Int. Miner. Processing Congr., Toronto, Canada, 1982.
- Pourbaix, M. I. N. *Thermodynamics of Dilute Aqueous Solutions*. London: Edward Arnold, 1949.
- Powell, J. H. The Bathymetry and Water Quality of Empress Augusta Bay With Notes on the Sediment Plume. BCM Rep. RB 109, 1977.
- Powell, J. H., and J. Simiha. Deposition Pattern of Tailings in Empress Augusta Bay and The Morphology of the Delta. BCM Rep. RB 043, 1979.
- Pradvcic, V. Surface Charge Characterization of Sea Sediments. *Limnol. Oceanogr.*, v. 15, 1970, pp. 230-233.
- Prior, D. B., and J. M. Coleman. Submarine Landslides - Geometry and Nomenclature. *Z. Geomorphology N. F.*, v. 23, No. 4, 1979, pp. 415-426.
- Proceedings of the Metallurgical Society of the Canadian Institute of Mining and Metallurgy. Tailings and Effluent Management. Int. Symp. on Tailings and Effluent Management/ Halifax, Aug. 20-24, v. 14, 1989, 336 p.
- RTZ Ice Station Mine. RTZ Rev., v. 16, 1990, pp. 14-17.
- Rambold, P. S., and D. J. Stucchi. An Analysis of the Alice Arm Crash Program Data - Summer 1981. *Can. Tech. Rep. Hydrog. Ocean Sci.*, v. 25, 1983, 66 pp.
- Ramming, H. G., and Z. Kowalik. Numerical Modeling of Marine Hydrodynamics. Elsevier Oceanogr. Ser., 26. Elsevier, 1980, 368 pp.
- Read, A. D., and R. M. Manser. Mineral Flotation-A Study of the Re-Use and Disposal of Aqueous Solutions Containing Organic Reagents. *Water Res.*, v. 10, 1976, pp. 243-251.
- Reim, K. M., F. A. Leonard, and R. B. Ellingson. Planning Considerations for Quartz Hill Mine, Southeast Alaska. *Annu. Meet. Soc. Min. Eng.*, Phoenix, AZ., Rep. 88-53, 1988, 9 pp.
- Rescan. Tailings Disposal Offshore Feasibility Study. Rep. to Southern Peru Copper Corp., Vancouver, B. C., 1991.
- Rescan Environmental Services, Ltd. Review of Recent Physical Oceanography and Tailings Disposal Modeling Studies of Wilson Arm/Smeaton Bay. 1985.

- Rescan Environmental Services, Ltd. Preliminary Tests of Kitsault Mill Tailings Plume Leaching Potential. Prepared For AMAX on Canada, Ltd., 1982.
- Rescan Environmental Services, Ltd. Suspended Solids Survey of Rupert Inlet, B.C. U. S. Borax and Chem. Corp., Vancouver, B. C., 1983.
- Rescan Environmental Services, Ltd. Assessment of Three Submarine Disposal Site Alternatives for the Quartz Hill Molybdenum Project, Southeast Alaska. U. S. Borax and Chem. Corp., 1984.
- Reserve Mining Company. Plant to Modify Tailings Discharge System. Silver Bay, MN., 1971.
- Ressner, P., A. Salazar, and P. Wellmann. Tailings Disposal in Seismic Zones. Ch. in Tailings Disposal Today, ed. by C. L. Alpin and G. O. Argall Jr., Miller Freeman, v. 2, 1979, p. 284.
- Rhoads, D. C., and J. D. Germano. Characterization of Organism Sediment Relations Using Sediment Profile Imaging: An Efficient Method of Remote Ecological Monitoring of the Seafloor (Remote System). Mar. Ecol. Prog. Ser., v. 8, 1982, pp. 115-128.
- Risenbrough, R., et al. Monitoring Strategies for the Protection of the Coastal Zone. The Natl. Res. Council, Natl. Acad. of Sci., Washington, D. C., 1980.
- Ritcey, G. M. Tailings Management; Problems and Solutions in the Mining Industry. Elsevier, 1989, 970 pp.
- Robb, M. S. Composition and Manganese Association of Suspended Matter at the Head of a Southeast Alaskan Fjord. M. S. Thesis, Univ. of AK., Fairbanks, 1981.
- Roberts, P. J. W. Mixing and Transport: A Literature Review. J. Water Pollut. Control Fed., v. 55, 1983, pp. 752-757.
- Royer, T. C. Coastal Fresh Water Discharge in the Northeast Pacific. J. Geophys. Res., v. 87, 1982, p. 2017.
- Rusanowski, P. C. Nome Offshore Placer Project Issues and Answers - A Three Year Perspective. Pres. at: 11th Annu. Conf. on Placer Min. Mar. 29 - Apr. 1, 1989. Fairbanks, AK., 1989, 23 pp.
- Rusanowski, P. C. Nome Offshore Project: Synthesis Report 1988. Prepared by West Gold Explor. and Min. Comp. Anchorage, Alaska for West Gold Explor. and Min. Co., Nome, AK., 1989, 13 pp.
- Rusanowski, P. C. BIMA Configuration Analysis Summary. Western Gold Expl. Min. Co., 1990, 18 pp.
- Rusanowski, P. C. and C. L. MacCay. Nome Offshore Placer Project: 1989 Synthesis Report. Prepared by ENSR (Doc. No. 7235-007) for West Gold Explor. and Min. Co., Nome, AK., 1990, 48 pp.
- Rusanowski, P. C., and L. A. Gardner. Nome Offshore Placer Project: Synthesis Report 1988. Western Gold Expl. and Min. Co., Nome, AK., 1989, 13 pp.
- Rusanowski, P. C., L. A. Gardner, and S. C. Jewett. Nome Offshore Placer Project: Annual Report 1986. Prepared by NORTEC Inc. and Inst. Mar. Sci. Univ. of AK., for Inspiration Gold, Inc., Nome, AK., 1978, 178 pp.
- Rusanowski, P. C., L. A. Gardner, and S. C. Jewett. Nome Offshore Placer Project: Annual Report 1987. Prepared by NORTEC Inc. and the Inst. of Mar. Sci. Univ. of AK. for Westgold Explor. and Min. Co., Nome, AK., 1988, 213 pp.
- Rusanowski, P. C., L. A. Gardner, and S. C. Jewett. Nome Offshore Placer Project: Data Report and Proposed Long-term Monitoring Plan (AK 004319-2). Prepared by NORTEC Inc. and the Inst. Mar. Sci. Univ. of AK., for Inspiration Mines Inc., Claypool, AZ., 1986, 135 pp.
- Ryan, J. P. and A. N. Findikakis. An Overview of Field and Modeling Program in the Submarine Disposal of Mine Tailings for the Quartz Hill Molybdenum Project. Apr. 21-25, 1986.

- Ryan, P. J. Behavior of Sediment Laden Plumes on Steep Slopes, ASCE Specialty Conference. Water Forum '86, Long Beach, CA., 1986.
- Ryan, P. J. Study of Submarine Tailings Disposal in Boca de Quadra Summary Report. Bechtel Civil & Miner., Inc., 1983.
- Ryan, P. J. Submarine Tailings Disposal Studies, Appendix D: Behavior of the Tailings Plume in the Near Field. Prepared for United States Borax & Chem. Corp. by Bechtel Civil & Miner., Inc., San Francisco, 1983.
- Ryan, P.J. Revision to the Summary and Conclusions of Technical Memorandum, Study of Submarine Tailings Disposal in Boca de Quadra -- Summary Report. Bechtel Civil & Miner., Inc., 1985.
- Sakamoto, W. Study on the Process of River Suspension From Flocculation to Accumulation in an Estuary. Tokyo Daigaku Jaiyo Ken Kyojo Bull., v. 5, 1972, pp. 1-49.
- Salazar, R. C. The Tailings Disposal System at Atlas Consolidated Mining and Development Corp. Fifth Symp. on Miner. Resour. Develop. and the 24th Annu. Mine Safety Conf., 1979.
- Salazar, R. C., and R. I. Gonzales. Design, Construction and Operation of the Tailings Pipelines and Underwater Tailings Disposal System of Atlas Consolidated Mining and Development Corporation in The Philippines. Ch. 20 in Tailings Disposal Today, ed. by C. L. Aplin, and G. O. Argal Jr., Miller Freeman, 1974, pp 477-511.
- Salomons, W. and U. Foerstner. Management of Mine Tailings and Dredged Material. Springer, 1988.
- Samson, J. An Overview of Coastal and Marine Gold Placer Occurrences in Nova Scotia and British Columbia. Ocean Min. Div. EMR Canada, 1984, 158 pp.
- Samsun, J. Compilation of Information on Polymetallic Sulphide Deposits and Occurrences off the West Coast of Canada. Can. Oil and Gas Lands Admin. Ottawa, 1985, 58 pp.
- Schiefer, K. Environmental Monitoring. Can. Min. J., 1975, pp. 52-54.
- Schubel, J. R., H. H. Carter, and et al. Field Investigations of the Nature, Degree, and Extent of Turbidity Generated by Openwater Pipeline Disposal Operations. Tech. Rep. D-78-30, U. S. Army Eng. Waterways Experiment Station, Vicksburg, MS., 1969.
- Schubel, J. R., W. M. Wise, and J. Schoof. Questions about Dredging and Dredged Material Disposal in Long Island Sound. Spec. Rep. 18, Ref. 79-11, Mar. Sci. Res. Cent., State Univ. of NY., Stony Brook, 1979.
- Scott, J. S., and K. Bragg. Mine and Mill Wastewater Treatment, Economic and Technical Review. Rep. EPA 3-WP-75-5, Water Pollut. Control Directorate, EPA, Environ. Canada, 1975.
- Scott, M. D. Design Construction and Operation of a Long Large Diameter Polyethylene Tailings Pipeline. Trans. Soc. Min. Eng. AIME, v. 262, No. 2, 1977, pp. 148-155.
- Shirazi, M. A., and L. R. Davis. Workbook of Thermal Plume Prediction, Surface Discharge. Pac. Northwest Environ. Res. Lab. Rep., EPA-R2-72-005B, Corvallis, OR., v. 2, 1974.
- Shirazi, M. A., and L. R. Davis. Workbook of Thermal Plume Prediction, Submerged Discharge. EPA-R2-72-005a, v. 1, 1972.
- Simpson, W. R. Particulate Matter in the Oceans--Sampling Methods, Concentration, Size Distribution and Particle Dynamics. Oceanogr. Mar. Biol. Annu. Rev., v. 20, 1982, pp. 119-172.
- Singer, P. C., and W. Stumm. Acidic Mine Drainage: The Rate Determining Step. Sci., v. 167, 1970, pp. 1121-1123.
- Skei, J. The Entrapment of Pollutants in Norwegian Fjord Sediments--A Beneficial Situation for the North Sea. Spec. Pub. Int. Assoc. Sediment., v. 5, 1981, pp. 461-468.

- Skei, J. M. Dispersal and Retention of Pollutants in Norwegian Fjords. *Rapp P-V Reun. Cons. Perm. Int. Exp. Mer.*, v. 181, 1981, pp. 78-86.
- Skei, J. M., N. B. Price, and S. E. Calvert. Particulate Metals in Waters of Sorfjord West Norway. *Ambio.*, v. 2, 1973, pp. 122-124.
- Skei, J. M., N. B. Price, S. E. Calvert, and H. Holthedahl. The Distribution of Heavy Metals in Sediments of Sorfjord, West Norway. *Water, Air & Soil Pollut.*, v. 1, 1972, pp. 452-461.
- SMEC. Hydrologic Investigations for the Ok Tedi Project. Dampier Min. Co. Ltd. Prepared by Snowy Mountains Eng. Corp., Cooma, N.S.W., 1978, 209 pp.
- Smith, J. D. Modeling of Sediment Transport on Continental Shelves. Ch. in *The Sea*, ed. by E.D. Goldberg, I.N. McCave, J.J. O'Brein, and J.H. Steele. Wiley-Intersci., v. 6, 1977, pp. 539-577.
- Smith, J. D., and D. M. Farmer. Mixing Induced by Internal Hydraulic Disturbances in the Vicinity of Sills. Ch. in *Fjord Oceanogr.*, ed. by H. J. Freeland, D. M. Farmer, and C. D. Levings, Plenum, 1980, pp. 251-257.
- Snook, J. Marine Tailings Disposal Symposium. March 22-23, Ketchikan, AK, 1982.
- Snook, J. R. Petrology and Petrography of the Quartz Hill Molybdenite Deposit. Ch. 8 in *Mar. Tailings Disposal*, ed. by D. V. Ellis. *Ann Arbor Sci.*, 1982, pp. 279-289.
- State of Hawaii Ocean Resources Branch. Mining Development Scenario for Cobalt-Rich Manganese Crusts in the Exclusive Economic Zones of the Hawaiian Archipelago and Johnston Island. v. 38, 1987, 326 pp.
- Stephen, C. U., D. I. Mount, D. J. Hansen, J. H. Gentile, G. A. Chapman, and W. A. Brungs. Guidelines for Deriving Numerical National Water Quality Criteria for the Protection of Aquatic Organisms and Their Uses. Prepared by the U. S. EPA, Office of Res. and Develop., ERL, Duluth, MN., 1985, 98 pp.
- Stephens, K. Continuous Measurements of Turbidity. *Deep-Sea Res.*, v. 4, 1967, pp. 465-467.
- Stigebrandt, A. Vertical Diffusion Driven by Internal Waves in a Sill Fjord. *J. Phys. Oceano.*, v. 6, 1976, pp. 486-495.
- Stipp, S. L. Speciation in the Fe(II)-Fe(III)-SO(4)-H(2)O System at 25C and Low pH: Sensitivity of an Equilibrium Model to Uncertainties. Ch. in *Environ. Sci. and Technol.*, Am. Chem. Soc., Washington, D.C., v. 24, No. 5, 1990, pp. 699-706.
- Stone, R. B. History of Artificial Reef Use in the United States. Ch. 10 in *Artificial Reefs, Mar. and Fresh Water Applications*, ed. by F. M. D'Itri. Lewis. Chelsea. MI., 1985, pp. 3-12.
- Stucchi, D. J. The Tidal Jet in Rupert-Holberg Inlet. Ch. in *Fjord Oceanogr.*, ed. by H. J. Freeland, D. M. Farmer, and C. D. Levings, Plenum, 1980, pp. 491-498.
- Stucchi, D. J. The Tidal Jet in Rupert-Holberg Inlet, *B. C. Atmos. Oceanogr.*, v. 23, No. 2, 1985, pp. 118-136.
- Stucchi, D. J. and D. M. Farmer. Deep-Water Exchange in Rupert-Holberg Inlet. *Pac. Mar. Sci. Report 76-10*, Inst. of Ocean Sci., Patricia Bay, 1976.
- Sugai, S., W. R. Schell, A. Nevissi, S. Osen, and D. Huntamer. Aquatic Disposal Field Investigations Duwamish Waterway Disposal Site Puget Sound, Washington., Appendix D. Chemical and Physical Analyses of Water and Sediment in Relation to Disposal of Dredged Material in Elliott Bay, Volume II, September-December, 1976. WA. Univ. Seattle, Lab. of Radiation Ecol., Tech. Rep. D-77- 24-APP-D-VOL-2, U.S. Army Waterways Experiment Station, Vicksburg, MS., 1978.
- Svendsen, H. Exchange Processes Above Sill Level Between Fjords and Coastal Water. Ch. in *Fjord Oceanogr.*, ed. by H.J. Freeland, D.M. Farmer, and C.D. Levings, Plenum, 1980, 335 pp.
- Swartz, R. C. Techniques for Sampling and Analyzing the Marine Macrobenthos. EPA-600/3-78-030, 1978.

- Syvitski, J. P. M. Sedimentological Advances Concerning the Flocculation and Zooplankton Pelletization of Suspended Sediment in Howe Sound, British Columbia. Ch. in A Fjord Receiving Glacial Meltwater. Unpubl. Ph.D. Thesis, Univ. of B.C., 1978, 291 pp.
- Takenouti, A. Y., H. Natsume, and T. Miyata. On The Sinking and Diffusion of Bauxite Residue Discharged into the Sea. *Mar. Sci. Comm.*, v. 5, No. 3, 1979, pp. 195-215.
- Tatem, H. E., and J. H. Johnson. Aquatic Disposal Field Investigations, Duwamish Waterway Disposal Site, Puget Sound, Washington, Evaluative Summary. Tech. Rep. Army Eng. Waterways Experiment Station Vicksburg, MS., D-77-24, 1978.
- Tesaker, E. Sedimentation in Recipients, Disposal of Particulate Mine Waste. River and Harbor Lab., Norwegian Inst. of Tech. Trondheim STF60 A78105, 1978.
- Tesaker, E. Modelling of Suspension Currents. Symp. on Modelling Techniques, San Francisco, CA., ASCE, 1975, pp. 1385-1401.
- Tester, F. J. Municipal Engineering in the Canadian Arctic: Strathcona Sound - A Case Study. *Environ. Sci. Cent.*, Kananaskis, Univ. of Calgary, 1974, 49 pp.
- Tetrattech (ed.). Survey Report. Bathymetric Survey off Boca de Quadra Fjord, Southeast Alaska. Rep. Bechtel, 1982, 18 pp. and Appendices.
- Thomas, N. H. Air Demand Distortion in Hydraulic Models: Experimental Evidence of Bi-Modal Structure in Air Entraining Flows and a Scaling Analysis of Detrainment With Special Application to Siphon Priming. *Int. Conf. Hydraulic Modelling of Civil Eng. Structures*, Coventry, England, Sept. 22-24, 1984, pp. 253-272.
- Thomas, N. H., T. R. Auton, K. Sene, and J. C. R. Hunt. Entrapment and Transport of Bubbles by Transient Large Eddies in Multiphase Turbulent Shear Flows. *Int. Conf. Phys. Modelling of Multiphase Flow*, Coventry, England: Apr. 19-21, 1983, pp. 169-184.
- Thompson, J. A. J. and F. T. McComas. Copper and Zinc Levels in Submerged Mine Tailings at Britannia Beach, B. C. Fish. Res. Bd. *Can. Tech. Rep.*, 1974, pp. 437.
- Thompson, J. A. J., and D. W. Paton. Chemical Delineation of a Submerged Mine Tailings Plume in Rupert and Holberg Inlets, B. C. *Tech. Rep.*, Fish. and Mar. Serv., *Environ. Canada*, No. 506, 1975.
- Thorslund, A. E. Disposal of Contaminated Spoil in a Stratified Fjord – An Example From the Swedish West Coast. *Valten*, v. 31, No. 2, 1975, pp. 133-138.
- Turner, J. S. Buoyancy Effects in Fluids. Cambridge Univ., 1973, 367 pp.
- Tyler, W. D., and G. Beale. Amax Uses Practical Approach to Dewatering at its Sleeper Mine. Ch. in *Min. Eng., Soc. for Min. and Exploration*, Littleton, CO., v. 43, No. 2, 1991, pp. 199-294.
- U. S. Army Corps of Engineers. Dredge Disposal Study, San Francisco Bay and Estuary. Appendix G, *Phys. Impact Study*, 1975, 158 pp.
- U. S. Borax and Chemical Corporation. Buoyant Freshwater Tailings. Letter From J. S. Paulsen to U. S. Forest Service, 1985.
- U. S. Forest Service. Final Mining Development Concept Analysis Document. U. S. Borax Molybdenum Claims at Quartz Hill. Misty Fjords Natl. Monument, Tongass Natl. Forest, Alaska. *USDA Forest Service. Alaska Reg. Rep.*, No. 150, 1981.
- U. S. Forest Service. Mining Developing Concepts Analysis Document for the U. S. Borax Molybdenum Claims at Quartz Hill. Misty Fjords Natl. Monument, Tongass Natl. Forest, AK. *Alaska Reg. Rep.*, No.129, 1981.
- U. S. Min. Man. Ser. Proposed Polymetallic Sulfide Minerals Lease Offering Gorda Ridge Area. 1983, 580 pp.

- U.S. Borax (ed.). Quartz Hill Update. U.S. Borax Fact Sheet, 1985, 6 pp.
- U.S. Borax (ed.). 1974-1984- A Decade of Progress. U.S Borax Quartz Hill Molybdenum Project, 5th edn., 1984, 12 pp.
- U.S. Borax (ed.). A Conceptual Plan For Mineral Development. U.S Borax Quartz Hill Molybdenum Project, 1st edn., 1979, 15 pp.
- U.S. Borax (ed.). The Decision Phase. An Investment in Alaska's Future. U.S. Borax Quartz Hill Molybdenum Project, 6th edn., 1987, 12 pp.
- Underwater Mining Institute. Abstr. 17th Annual UMI. 1986.
- United States Borax & Chemical Corp. Comparative Assessment of Tailings Disposal Alternatives. 1983.
- USEPA. Processes, Coefficients, and Models for Simulating Toxic Organics and Heavy Metals in Surface Waters. Athens, GA. Office of Res. and Develop. EPA/600/3-87/015, 1987.
- Vanoni, V. A. Sedimentation Engineering. Am. Soc. of Civil Eng. Manuals and Rep. on Eng. Practice, No. 54, 1975.
- Veith, D. L., and L. M. Kaas. Mineral-Related Waste Management in the Bureau of Mines Environmental Technology Program. Ch. in 1988 Symp. on Min., Hydrol., Sedimentol., and Reclamation, Univ. of KY, Lexington, Dec. 5-9, 1988, pp. 7-12.
- Vick, S. G. Siting and Design of Tailings Impoundments. Min. Eng., v. 33, 1981, pp. 653-657.
- Vreugde, M. J. A., and G. W. Poling. The Effect of Flocculants on Reclaim Water Quality for Flotation. CIM Bull., 1975, pp. 1-6.
- VTN Consolidated, Inc. 1982 Boca de Quadra and Wilson Arm/Smeaton Bay Monitoring Study. 1982.
- VTN Consolidated, Inc. 1983 Benchmark Water Resources Report, Quartz Hill Molybdenum Project, Southeast Alaska. 1983.
- Wakeman, T. H. Release of Trace Constituents From Sediments Resuspended During Dredging Operations. Ch. in Chem. of Mar. Sediments, ed. by T. F. Yen, Ann Arbor Sci., 1977.
- Waldichuk, M. Disposal of Mine Wastes into the Sea. Mar. Poll. Bull., v. 9, No. 6, 1978, pp. 141-143.
- Waldichuk, M. The Disposal of Tailings From Yreka Mine, Neouroutsos Inlet. 1956 File-- M. W. and Newspaper Clippings.
- Ward, A. D., C. T. Haan, and B. J. Barfield. Prediction of Sediment Basin Performance. Trans. Am. Soc. Agr. Eng., v. 22, No. 1, 1979, pp. 126-136.
- Warren, L. J. Distribution of Heavy Metals Between the Minerals and Organic Debris in a Contaminated Marine Sediment. Am. Chem. Soc. Div. Environ. Chem. Prepr., v. 19, No. 1, 1979.
- Water Quality Institute, Denmark. Laboratory Assays on the Features of Silt and Tailing Material from Marmorilik. Project Rep. for Greenex A/S, 1980.
- Water Quality Institute, Denmark. Testing of Methods to Mitigate the Release of Metals from Fjord Sediments, Marmorilik. Project Rep. from Greenex A/S, Landemaerket 8, DK-11119, Copenhagen, Denmark, 1979.
- Webster, I. Kitimat Physical Oceanographic Study 1977-1978, Data Collection and Analyses. Dobrocky Seatech Ltd., Victoria, B. C., Prepared for Inst. of Ocean Sci., Sidney, B. C., 1979.
- Welling, C. G. The Future of U. S. Seabed Mining: An Industry View. Min. Cong. J., 1982, pp. 19-24.

- Western Canada Hydraulic Laboratories. Kitsault Mine Marine Tailings Disposal Study. Final Rep. to Climax Molybdenum Corp. of B. C. Ltd., Port Coquitlam, B. C., 1978.
- Westmin. Westmin: Myra Fall Operations. Resources Ltd. Campbell River, B. C.,
- Weston, R. F., and M. L. Woldman. Taconite Tailings Disposal, Reserve Mining Company, Silver Bay, Minnesota. Monitor, v. 18, 1971, pp. 179.
- Williams, R. E. Waste Production and Disposal of Mining, Milling and Metallurgical Industries. Miller Freeman, 1975.
- Willis, D. A. Site Investigation and Selection -- Engineering Aspects. Proc. Conf. Inst. of Civil Eng., London, 1980.
- Willson, J. M. Black Angel Mine -- A Danish/Canadian Development in Greenland. Min. Mag., v. 129, 1973, pp. 21.
- Wilson, H. R. Tailings Management in the Canadian Arctic: Echo Bay's Lupin Mine. Ch. in Min. Eng., Soc. for Min. and Expl., Littleton, CO., v. 43, No. 2, 1991, p. 214.
- Wiltshire, J. Offshore Outfall Disposal for a Hawaiian Manganese Nodule Processing Plant. Mar. Tech. Soc., Univ. of HI., Manoa, 1984, pp. 22-28.
- Wiltshire, J. C. The Potential of the Puna Submarine Canyon for Slurry Disposal of Manganese Nodule Tailings. Oceans (New York), v. 19, 1982, pp. 1069-1073.
- Winter, D. F. Studies of Circulation and Primary Production in Deep Inlet Environments. EPA-600/3-77-049, 1977.
- World Mining. Complex Forms of Waste Tailings From Recovery of Uranium and Gold. V. 33, No. 6, 1980, pp. 48-52.
- World Mining. Marcopper's Tailing Disposal System Mill to Sea in Pipes, Flumes, Drop Boxes. V. 30, No. 9, 1977, pp. 52-55.
- World Mining. Tailing - Canadian Regulations and Practice - Marine Disposal Systems. V. 31, No. 5, 1978, pp. 58-62.
- Wyllie, R. J. M. Repparfjord -- How To Open Pit Copper Ore at 70 Degrees N. Latitude. World Min., v. 26, No. 10, 1973, pp. 50-54.
- Wyllie, R. J. M. Mining Nepheline Syenite. World Min., v. 26, No. 9, 1973, pp. 38-41.
- Zapatka, M. C., and R. W. Hann Jr. Technical and Philosophical Aspects of Ocean Disposal. Texas A&M Univ. Sea Grant Program Rep. No. TAMU-SG-78-203, PB-279, 1977, pp. 971.